



FCC TEST REPORT

FCC ID: 2A8QD-XY-MBO6BA

On Behalf of

SHENZHEN NEWBIT INFO TECHNOLOGY CO.,LTD.

BLE Transmission Modules

Model No.: XY-MBO6BA, XY-MBO6BB, XY-MBO6BAP, XY-MBO6BBP

Prepared for : SHENZHEN NEWBIT INFO TECHNOLOGY CO.,LTD.
Address : Room 1616, Global Logistics Center Building, Longgang Dist,
Shenzhen, China

Prepared By : Shenzhen PSI Testing Co., Ltd.
Address : 1-2/F., Building 5, Yudafu Industrial Park, No.10, Xingye West Road,
Shajing Subdistrict, Bao'an District, Shenzhen, Guangdong, China

Report Number : psi2505085-C01-R01
Date of Receipt : May 15, 2025
Date of Test : May 15, 2025-May 27, 2025
Date of Report : May 27, 2025
Version Number : V0

TABLE OF CONTENTS

| Description | Page |
|--|-----------|
| 1. Summary Of Standards And Results ----- | 6 |
| 1.1. Description of Standards and Results ----- | 6 |
| 2. General Information ----- | 7 |
| 2.1. Description of Device (EUT) ----- | 7 |
| 2.2. Accessories of Device (EUT) ----- | 8 |
| 2.3. Tested Supporting System Details----- | 8 |
| 2.4. Block Diagram of Connection Between EUT and Simulators----- | 8 |
| 2.5. Test Mode Description----- | 9 |
| 2.6. Software test version and power setting information----- | 9 |
| 2.7. Test Conditions----- | 10 |
| 2.8. Test Facility----- | 10 |
| 2.9. Measurement Uncertainty ----- | 10 |
| 2.10. Test Equipment List ----- | 11 |
| 3. Spurious Emission ----- | 12 |
| 3.1. Test Limits ----- | 12 |
| 3.2. Block Diagram of Test setup ----- | 15 |
| 3.3. Test Procedure ----- | 16 |
| 3.4. Test Results ----- | 17 |
| 4. Power Line Conducted Emission ----- | 23 |
| 4.1. Test Limits ----- | 23 |
| 4.2. Test Procedure ----- | 23 |
| 4.3. Test Setup ----- | 23 |
| 4.4. Test Results ----- | 24 |
| 5. Out-of-band Emissions ----- | 27 |
| 5.1. Test Limits ----- | 27 |
| 5.2. Test Procedure ----- | 27 |
| 5.3. Test Setup ----- | 27 |
| 5.4. Test Results ----- | 27 |
| 6. Conducted Maximum Output Power ----- | 38 |
| 6.1. Test limits ----- | 38 |
| 6.2. Test Procedure ----- | 38 |
| 6.3. Test Setup ----- | 38 |
| 6.4. Test Results ----- | 38 |
| 7. Peak Power Spectral Density ----- | 42 |
| 7.1. Test limits ----- | 42 |
| 7.2. Test Procedure ----- | 42 |
| 7.3. Test Setup ----- | 42 |
| 7.4. Test Results ----- | 42 |
| 8. Bandwidth ----- | 46 |
| 8.1. Test limits ----- | 46 |
| 8.2. Test Procedure ----- | 46 |
| 8.3. Test Setup ----- | 46 |
| 8.4. Test Results ----- | 46 |
| 9. Band Edge Test ----- | 53 |
| 9.1. Block Diagram of Test Setup----- | 53 |
| 9.2. Test Limit----- | 53 |
| 9.3. Test Procedure ----- | 53 |
| 9.4. Test Results ----- | 54 |
| 10. Frequency stability ----- | 56 |
| 10.1. Test limit----- | 56 |
| 10.2. Test Procedure ----- | 56 |
| 10.3. Test Setup ----- | 56 |

| | |
|--|-----------|
| 10.4. Test Results ----- | 56 |
| 11. Antenna Requirement----- | 57 |
| 11.1. Standard Requirement ----- | 57 |
| 11.2. Antenna Connected Construction ----- | 57 |
| 11.3. Results ----- | 57 |
| 12. Photos of test setup ----- | 58 |
| 13. Photos of EUT ----- | 58 |

TEST REPORT DECLARATION

Applicant : SHENZHEN NEWBIT INFO TECHNOLOGY CO.,LTD.
 Address : Room 1616, Global Logistics Center Building, Longgang Dist, Shenzhen, China
 Manufacturer : SHENZHEN NEWBIT INFO TECHNOLOGY CO.,LTD.
 Address : Room 1616, Global Logistics Center Building, Longgang Dist, Shenzhen, China
 EUT Description : BLE Transmission Modules
 (A) Model No. : XY-MBO6BA, XY-MBO6BB, XY-MBO6BAP, XY-MBO6BBP
 (B) Trademark : N/A

Measurement Standard Used:

FCC Rules and Regulations Part 15 Subpart C Section 15.247

ANSI C63.10:2013

Test Result: PASS

The device described above is tested by Shenzhen PSI Testing Co., Ltd. to determine the maximum emission levels emanating from the device and the severe levels of the device can endure and its performance criterion. The test results are contained in this test report and Shenzhen PSI Testing Co., Ltd. is assumed full responsibility for the accuracy and completeness of test. Also, this report shows that the EUT is technically compliant with the FCC Part 15C requirements.

This report applies to above tested sample only. This report shall not be reproduced in parts without written approval of Shenzhen PSI Testing Co., Ltd.

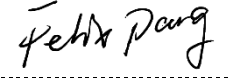
Tested by (name + signature).....: Felix Pang
 Test Engineer 

Approved by (name + signature).....: Simple Guan
 Project Manager 

Date of issue.....: May 27, 2025

Revision History

| Revision | Issue Date | Revisions | Revised By |
|----------|--------------|------------------------|------------|
| V0 | May 27, 2025 | Initial released Issue | Felix Pang |

1. Summary Of Standards And Results

1.1. Description of Standards and Results

The EUT have been tested according to the applicable standards as referenced below:

| Test Item | Standards Paragraph | Result |
|---|--|--------|
| Conducted Emission | FCC Part 15: 15.207 RSS-GEN(8.8), ANSI C63.10 :2013 | P |
| 6dB Bandwidth | FCC PART 15:15.247(a)(2) RSS-247(5.2 a), ANSI C63.10 :2013 | P |
| Output Power | FCC Part 15: 15.247(b)(3) RSS-247(5.4 d), ANSI C63.10 :2013 | P |
| Radiated Spurious Emission | FCC Part 15: 15.209 FCC Part 15: 15.247(d) RSS-Gen(8.9), RSS-247(5.5) ANSI C63.10 :2013 | P |
| Conducted Spurious & Band Edge Emission | FCC Part 15: 15.247(d) RSS-Gen(8.9), RSS-247(5.5) ANSI C63.10 :2013 | P |
| Power Spectral Density | FCC PART 15:15.247(e) RSS-247(5.2 b), ANSI C63.10 :2013 | P |
| Radiated Band Edge Emission | FCC Part 15: 15.247(d) RSS-GEN(6.13), ANSI C63.10 :2013 | P |
| Frequency stability | RSS-GEN(6.11) | N/A |
| Antenna Requirement | FCC Part 15: 15.203 RSS-GEN(6.8) | P |
| <p>Note: 1. P is an abbreviation for Pass. 2. F is an abbreviation for Fail. 3. N/A is an abbreviation for Not Applicable. 4. Conclusion determination rules of this report: Unless there are clear provisions on measurement uncertainty in the standard or customer requirements, decision by actual test data without considering measurement uncertainty. 5. Measurement method usage KDB 558074 D01 15.247 Meas Guidance v05r02.</p> | | |

2. General Information

2.1. Description of Device (EUT)

Product Name : BLE Transmission Modules
Model No. : XY-MBO6BA, XY-MBO6BB, XY-MBO6BAP, XY-MBO6BBP
Diff : There is no difference except the name of the model. All tests are made with the XY-MBO6BA model.
Power supply : DC 1.8~3.3V

Radio Technology : Bluetooth V5.3 LE
Operation frequency : 2402-2480MHz
Channel No. : 40 channels
Channel Separation : 2MHz
Rate : 1Mbps/2Mbps
Modulation : GFSK
Antenna Type : PCB antenna, maximum gain is -0.5dBi.

PMN : N/A
HVIN : N/A

Software version : V1.0
Hardware version/FVIN : V1.0

Note : Antenna information is provided by applicant.
Testing lab is not responsible for the accuracy of the information.

2.2. Accessories of Device (EUT)

Accessories 1 : USB cable
 Manufacturer : N/A
 Model : N/A
 Rating : N/A

2.3. Tested Supporting System Details

| No. | Description | Manufacturer | Model | Serial Number |
|-----|-------------|--------------|---------------|---------------|
| 1 | USB to TTL | Yunxin | CH340G | N/A |
| 2 | Notebook PC | Dell | Latitude 3490 | N/A |

2.4. Block Diagram of Connection Between EUT and Simulators

CE:

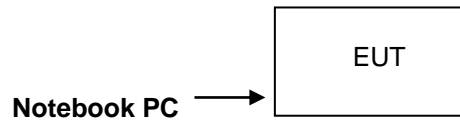

RSE:

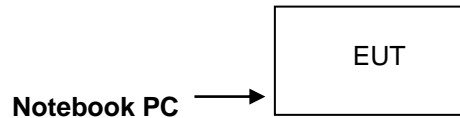

2.5. Test Mode Description

The test software was used to control EUT work in Continuous TX mode, and select test channel, wireless mode

| Tested mode, channel, and data rate information | | |
|---|---------|-----------------|
| Mode | Channel | Frequency (MHz) |
| GFSK Tx Mode 1Mbps/2Mbps | CH0 | 2402 |
| | CH19 | 2440 |
| | CH39 | 2480 |

| Channel list: | | | | | |
|---------------|-----------------|---------|-----------------|---------|-----------------|
| Channel | Frequency (MHz) | Channel | Frequency (MHz) | Channel | Frequency (MHz) |
| CH0 | 2402 | CH14 | 2430 | CH28 | 2458 |
| CH1 | 2404 | CH15 | 2432 | CH29 | 2460 |
| CH2 | 2406 | CH16 | 2434 | CH30 | 2462 |
| CH3 | 2408 | CH17 | 2436 | CH31 | 2464 |
| CH4 | 2410 | CH18 | 2438 | CH32 | 2466 |
| CH5 | 2412 | CH19 | 2440 | CH33 | 2468 |
| CH6 | 2414 | CH20 | 2442 | CH34 | 2470 |
| CH7 | 2416 | CH21 | 2444 | CH35 | 2472 |
| CH8 | 2418 | CH22 | 2446 | CH36 | 2474 |
| CH9 | 2420 | CH23 | 2448 | CH37 | 2476 |
| CH10 | 2422 | CH24 | 2450 | CH38 | 2478 |
| CH11 | 2424 | CH25 | 2452 | CH39 | 2480 |
| CH12 | 2426 | CH26 | 2454 | -- | -- |
| CH13 | 2428 | CH27 | 2456 | -- | -- |

2.6. Software test version and power setting information

| Software testing version | RF_Test.exe REV 1.0.0.0 | | |
|-----------------------------|--|-----------------|------------------------------------|
| Mode | The client 's preset testing software is used to control the operation of EUT in continuous transmission mode and select the testing channel, wireless mode: | | |
| Power level setup by client | | | |
| Mode | Channel | Frequency (MHz) | Soft Set |
| GFSK Tx Mode 1Mbps/2Mbps | CH0 | 2402 | TX level is set as defaults value. |
| | CH19 | 2440 | TX level is set as defaults value. |
| | CH39 | 2480 | TX level is set as defaults value. |

2.7. Test Conditions

| Items | Required | Actual |
|--------------------|-----------|--------|
| Temperature range: | 15-35°C | 26°C |
| Humidity range: | 25-75% | 54% |
| Pressure range: | 86-106kPa | 101kPa |

2.8. Test Facility

Shenzhen PSI Testing Co., Ltd.

1-2/F., Building 5, Yudafu Industrial Park, No.10, Xingye West Road, Shajing Subdistrict, Bao'an District, Shenzhen, Guangdong, China

September 13, 2023 File on Federal Communication Commission

Registration Number: 916281

2.9. Measurement Uncertainty

(95% confidence levels, k=2)

| Item | Uncertainty |
|--|---------------------|
| Uncertainty for Power point Conducted Emissions Test | 2.17dB |
| Uncertainty for Radiation Emission test in 3m chamber (below 30MHz) | 3.5dB |
| Uncertainty for Radiation Emission test in 3m chamber (30MHz to 1GHz) | 2.74dB(Polarize: V) |
| | 2.76dB(Polarize: H) |
| Uncertainty for Radiation Emission test in 3m chamber (1GHz to 18GHz) | 4.29dB(Polarize: V) |
| | 4.82dB(Polarize: H) |
| Uncertainty for Radiation Emission test in 3m chamber (18GHz to 40GHz) | 4.31dB(Polarize: V) |
| | 4.30dB(Polarize: H) |
| Uncertainty for radio frequency | 48.24KHz |
| Uncertainty for conducted RF Power | 0.41dB |
| Uncertainty for Power Spectral Density | 0.39 dB |

2.10. Test Equipment List

| Item | Equipment | Manufacturer | Model No. | Serial No. | Firmware Version | Last Cal. | Cal. Interval |
|------|---------------------------|---------------|-------------------|--------------------------|------------------|------------|---------------|
| 1. | 9*6*6 anechoic chamber | SKET | 9*6*6 | N/A | / | 2022.12.20 | 3 Year |
| 2. | Test Receiver | Rohde&Schwarz | ESCI 7 | 101032/003 | 4.42 SP3 | 2024.12.18 | 1 Year |
| 3. | L.I.S.N.#1 | Rohde&Schwarz | ENV216 | 102282 | / | 2024.12.18 | 1 Year |
| 4. | L.I.S.N.#2 | RFT | NNB111 | 13835240 | / | 2024.12.18 | 1 Year |
| 5. | Loop Antenna | Schwarz beck | FMZB 1519B | 00128 | / | 2025.01.02 | 2 Year |
| 6. | Bilog Antenna | Schwarz beck | VULB 9168 | 01448 | / | 2025.01.02 | 2 Year |
| 7. | Spectrum Analyzer | Rohde&Schwarz | FSV-40N | 101648 | 3.70 | 2024.12.18 | 1 Year |
| 8. | Horn Antenna | Schwarz beck | BBHA 9120 D | 02706 | / | 2025.01.02 | 2 Year |
| 9. | Amplifier | SKET | LAPA_01G1 8G-45dB | SK20220329 01 | / | 2024.12.18 | 1 Year |
| 10. | Horn Antenna | Schwarz beck | BBHA 9170 | 00946 | / | 2024.12.31 | 2 Year |
| 11. | Amplifier | SKET | LNPA_0118 G-45 | SK20200108 01 | / | 2024.12.18 | 1 Year |
| 12. | RF Power Probe | Rohde&Schwarz | NRP-Z11 | 1138.3004.0 2-1111533-Fz | / | 2024.12.18 | 1 Year |
| 13. | RF Sensor Unit | Tachoy | TR1029-2 | 20220428P0 08 | / | 2024.12.18 | 1 Year |
| 14. | Spectrum Analyzer | Agilent | N9020A | MY51281067 | A.14.03 | 2024.12.18 | 1 Year |
| 15. | Temp. & Humid Chamber | Auchno | 9606 | / | / | 2024.12.18 | 1 Year |
| 16. | Regulated DC Power Supply | Xinouhua | ADC120V10 A | 2022112516 38 | | 2024.12.18 | 1 Year |
| 17. | Power meter | Agilent | E4419B | GB40202121 | / | 2024.12.18 | 1 Year |

For Test Software Information

| Item | Software Name | Manufacturer | Version |
|------|---------------|--------------|---------|
| RE | EZ_EMG | Farad | PSI-3A1 |
| CE | EZ_EMG | Farad | PSI-3A1 |
| RF | RTS | TACHOY | V1.0.0 |

3. Spurious Emission

3.1. Test Limits

All the emissions appearing within 15.205 restricted frequency bands shall not exceed the limits shown in 15.209, all the other emissions shall be at least 20dB below the fundamental emissions, or comply with 15.209 limits.

15.205 Restricted frequency band

| MHz | MHz | MHz | GHz |
|----------------------------|-----------------------|-----------------|------------------|
| 0.090 - 0.110 | 16.42 - 16.423 | 399.9 - 410 | 4.5 - 5.15 |
| ¹ 0.495 - 0.505 | 16.69475 - 16.69525 | 608 - 614 | 5.35 - 5.46 |
| 2.1735 - 2.1905 | 16.80425 - 16.80475 | 960 - 1240 | 7.25 - 7.75 |
| 4.125 - 4.128 | 25.5 - 25.67 | 1300 - 1427 | 8.025 - 8.5 |
| 4.17725 - 4.17775 | 37.5 - 38.25 | 1435 - 1626.5 | 9.0 - 9.2 |
| 4.20725 - 4.20775 | 73 - 74.6 | 1645.5 - 1646.5 | 9.3 - 9.5 |
| 6.215 - 6.218 | 74.8 - 75.2 | 1660 - 1710 | 10.6 - 12.7 |
| 6.26775 - 6.26825 | 108 - 121.94 | 1718.8 - 1722.2 | 13.25 - 13.4 |
| 6.31175 - 6.31225 | 123 - 138 | 2200 - 2300 | 14.47 - 14.5 |
| 8.291 - 8.294 | 149.9 - 150.05 | 2310 - 2390 | 15.35 - 16.2 |
| 8.362 - 8.366 | 156.52475 - 156.52525 | 2483.5 - 2500 | 17.7 - 21.4 |
| 8.37625 - 8.38675 | 156.7 - 156.9 | 2690 - 2900 | 22.01 - 23.12 |
| 8.41425 - 8.41475 | 162.0125 - 167.17 | 3260 - 3267 | 23.6 - 24.0 |
| 12.29 - 12.293 | 167.72 - 173.2 | 3332 - 3339 | 31.2 - 31.8 |
| 12.51975 - 12.52025 | 240 - 285 | 3345.8 - 3358 | 36.43 - 36.5 |
| 12.57675 - 12.57725 | 322 - 335.4 | 3600 - 4400 | (²) |

RSS-GEN Restricted frequency band

Table 7 – Restricted frequency bands^{Note 1}

| MHz | MHz | GHz |
|-------------------|-----------------------|---------------|
| 0.090 - 0.110 | 149.9 - 150.05 | 9.0 - 9.2 |
| 0.495 - 0.505 | 156.52475 - 156.52525 | 9.3 - 9.5 |
| 2.1735 - 2.1905 | 156.7 - 156.9 | 10.6 - 12.7 |
| 3.020 - 3.026 | 162.0125 - 167.17 | 13.25 - 13.4 |
| 4.125 - 4.128 | 167.72 - 173.2 | 14.47 - 14.5 |
| 4.17725 - 4.17775 | 240 – 285 | 15.35 - 16.2 |
| 4.20725 - 4.20775 | 322 - 335.4 | 17.7 - 21.4 |
| 5.677 - 5.683 | 399.9 - 410 | 22.01 - 23.12 |
| 6.215 - 6.218 | 608 - 614 | 23.6 - 24.0 |
| 6.26775 - 6.26825 | 960 - 1427 | 31.2 - 31.8 |

| | | |
|---------------------|-----------------|--------------|
| 6.31175 - 6.31225 | 1435 - 1626.5 | 36.43 - 36.5 |
| 8.291 - 8.294 | 1645.5 - 1646.5 | Above 38.6 |
| 8.362 - 8.366 | 1660 - 1710 | |
| 8.37625 - 8.38675 | 1718.8 - 1722.2 | |
| 8.41425 - 8.41475 | 2200 - 2300 | |
| 12.29 - 12.293 | 2310 - 2390 | |
| 12.51975 - 12.52025 | 2483.5 - 2500 | |
| 12.57675 - 12.57725 | 2655 - 2900 | |
| 13.36 - 13.41 | 3260 – 3267 | |
| 16.42 - 16.423 | 3332 - 3339 | |
| 16.69475 - 16.69525 | 3345.8 - 3358 | |
| 16.80425 - 16.80475 | 3500 - 4400 | |
| 25.5 - 25.67 | 4500 - 5150 | |
| 37.5 - 38.25 | 5350 - 5460 | |
| 73 - 74.6 | 7250 - 7750 | |
| 74.8 - 75.2 | 8025 – 8500 | |
| 108 – 138 | | |

Note 1: Certain frequency bands listed in table 7 and in bands above 38.6 GHz are designated for licence-exempt applications. These frequency bands and the requirements that apply to related devices are set out in the 200 and 300 series of RSS.

15.209 Limit

| FREQUENCY MHz | DISTANCE Meters | FIELD STRENGTHS LIMIT | |
|------------------|--------------------|---|-----------------------------------|
| | | $\mu\text{V}/\text{m}$ | $\text{dB}(\mu\text{V})/\text{m}$ |
| 0.009-0.490 | 300 | $2400/F(\text{KHz})$ | / |
| 0.490-1.705 | 30 | $24000/F(\text{KHz})$ | / |
| 1.705-30 | 30 | 30 | 29.5 |
| 30 ~ 88 | 3 | 100 | 40.0 |
| 88 ~ 216 | 3 | 150 | 43.5 |
| 216 ~ 960 | 3 | 200 | 46.0 |
| 960 ~ 1000 | 3 | 500 | 54.0 |
| Above 1000 | 3 | 74.0 $\text{dB}(\mu\text{V})/\text{m}$ (Peak) 54.0 $\text{dB}(\mu\text{V})/\text{m}$ (Average) | |

Note: The peak limit is 20 dB higher than the average limit

Table 5 – General field strength limits at frequencies above 30 MHz

| Frequency (MHz) | Field strength ($\mu\text{V}/\text{m}$ at 3 m) |
|-----------------|---|
| 30 – 88 | 100 |
| 88 – 216 | 150 |
| 216 – 960 | 200 |
| Above 960 | 500 |

Table 6 – General field strength limits at frequencies below 30 MHz

| Frequency | Magnetic field strength (H-Field) ($\mu\text{A}/\text{m}$) | Measurement distance (m) |
|-------------------------------|--|--------------------------|
| 9 - 490 kHz ^{Note 1} | $6.37/F$ (F in kHz) | 300 |
| 490 - 1705 kHz | $63.7/F$ (F in kHz) | 30 |
| 1.705 - 30 MHz | 0.08 | 30 |

Note 1: The emission limits for the ranges 9-90 kHz and 110-490 kHz are based on measurements employing a linear average detector.

3.2. Block Diagram of Test setup

3.2.1 In 3m Anechoic Chamber Test Setup Diagram for below 30MHz

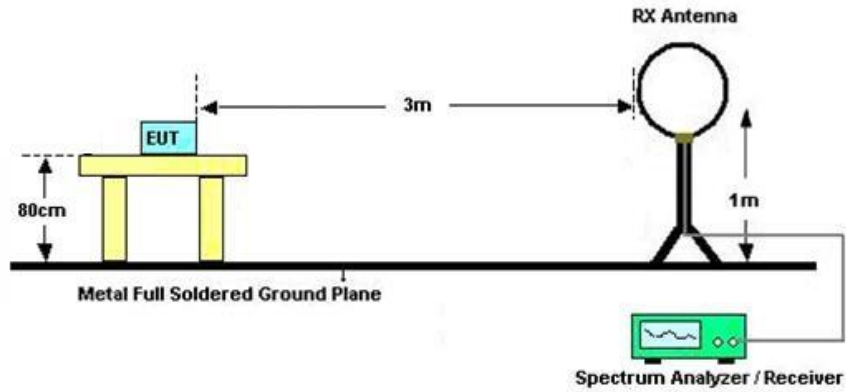

3.2.2 In 3m Anechoic Chamber Test Setup Diagram for below 1GHz

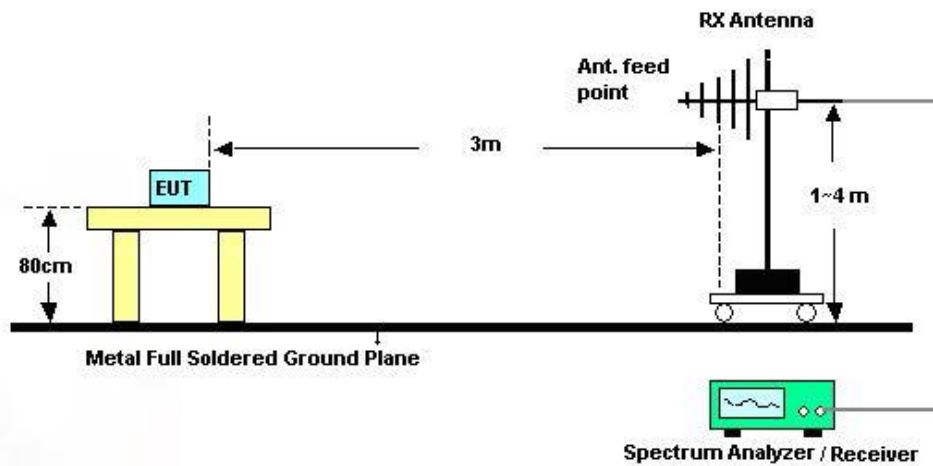

3.2.3 In 3m Anechoic Chamber Test Setup Diagram for frequency above 1GHz

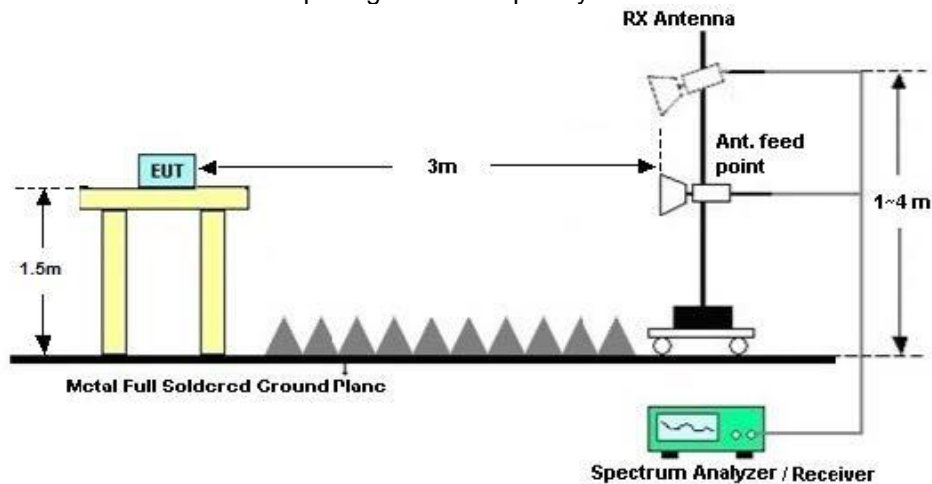

3.3. Test Procedure

- (1) EUT was placed on a non-metallic table, 80 cm above the ground plane inside a semi-anechoic chamber.
- (2) Setup EUT and simulator
- (3) Test antenna was located 3m from the EUT on an adjustable mast. Below pre-scan procedure was first performed in order to find prominent radiated emissions.
 - (a) Change work frequency or channel of device if practicable.
 - (b) Change modulation type of device if practicable.
 - (c) Rotated EUT though three orthogonal axes to determine the attitude of EUT arrangement produces highest emissions
- (4) Spectrum frequency from 9KHz to 25GHz (tenth harmonic of fundamental frequency) was investigated
- (5) For final emissions measurements at each frequency of interest, the EUT were rotated and the antenna height was varied between 1m and 4m in order to maximize the emission. Measurements in both horizontal and vertical polarities were made and the data was recorded. In order to find the maximum emission, the relative positions of equipments and all of the interface cables were changed according to ANSI C63.10:2013on Radiated Emission test.
- (6) For emissions above 1GHz, both Peak and Average level were measured with Spectrum Analyzer, and the BW is set at 1MHz, VBW is set at 3MHz for Peak measure; RBW is set at 1MHz, VBW is set at 10Hz for Average measure.

Test setup information:

| | | |
|--------------|-----------|------------|
| 9KHz~150KHz | RBW200Hz | VBW1KHz |
| 150KHz~30MHz | RBW9KHz | VBW 30KHz |
| 30MHz~1GHz | RBW120KHz | VBW 300KHz |
| Above1GHz | RBW1MHz | VBW 3MHz |

3.4. Test Results

We have scanned from 9kHz to the 10th harmonic of the EUT's highest frequency.
Detailed information please see the following page.

| | |
|----------------------------|--|
| From 9KHz to 30MHz: | |
| Test Date : 2025.05.26 | Temperature : 26°C |
| Test Engineer : Felix Pang | Humidity : 54% |
| Test Mode : GFSK mode | |
| Test Results : PASS | |
| Note: | The amplitude of spurious emissions which are attenuated by more than 20dB below the permissible value has no need to be reported. |

| | |
|----------------------------|--|
| From 30MHz to 1000MHz: | |
| Test Date : 2025.05.26 | Temperature : 26°C |
| Test Engineer : Felix Pang | Humidity : 54% |
| Test Mode : GFSK mode | |
| Test Results : PASS | |
| Note: | <ol style="list-style-type: none"> 1. The test results are listed in next pages. 2. If the limits for the measurement with the average detector are met when using a receiver with a peak detector, the test unit shall be deemed to meet both limits and the measurement with the average detector and quasi-peak detector need not be carried out. 3. All modes have been tested, and only worst data of 1Mbps GFSK 2402MHz mode was listed in this report. |

Polarization: Vertical

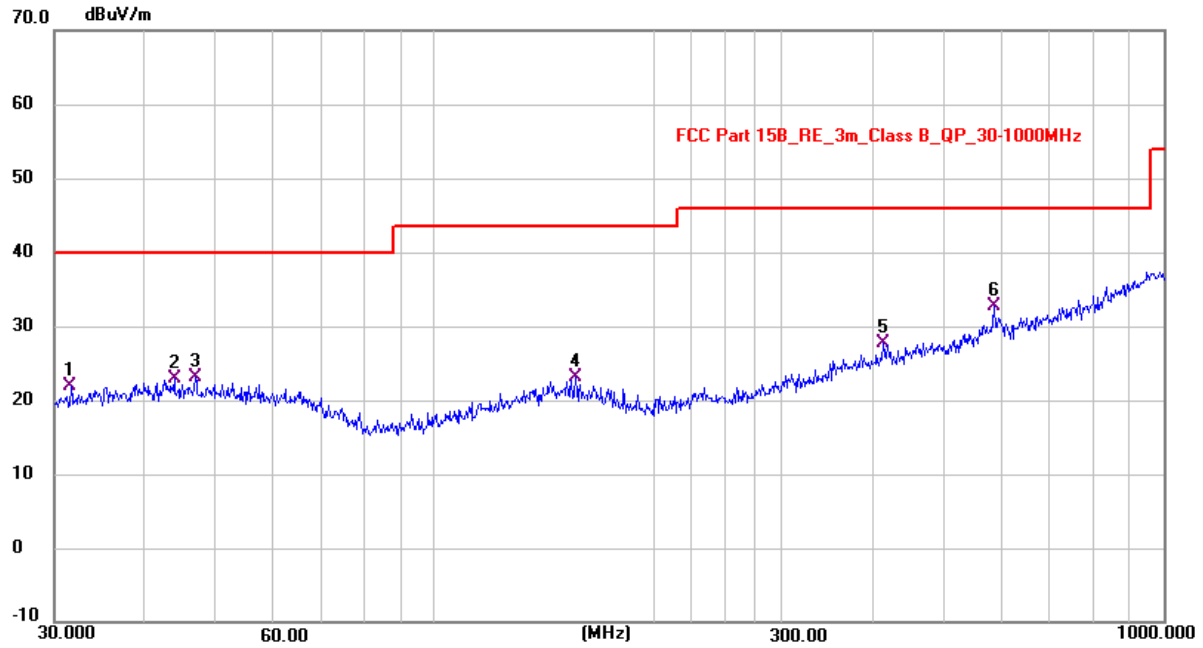

| No. | Frequency (MHz) | Reading (dBuV) | Factor (dB/m) | Level (dBuV/m) | Limit (dBuV/m) | Margin (dB) | Detector |
|-----|-----------------|----------------|---------------|----------------|----------------|-------------|----------|
| 1 | 31.6479 | 9.48 | 12.36 | 21.84 | 40.00 | -18.16 | QP |
| 2 | 43.9080 | 9.34 | 13.47 | 22.81 | 40.00 | -17.19 | QP |
| 3 | 46.9330 | 9.77 | 13.33 | 23.10 | 40.00 | -16.90 | QP |
| 4 | 156.0468 | 9.97 | 13.17 | 23.14 | 43.50 | -20.36 | QP |
| 5 | 412.7276 | 11.27 | 16.45 | 27.72 | 46.00 | -18.28 | QP |
| 6 * | 585.0459 | 12.41 | 20.34 | 32.75 | 46.00 | -13.25 | QP |

Note: Level = Reading + Factor Margin = Level - Limit

Polarization: Horizontal

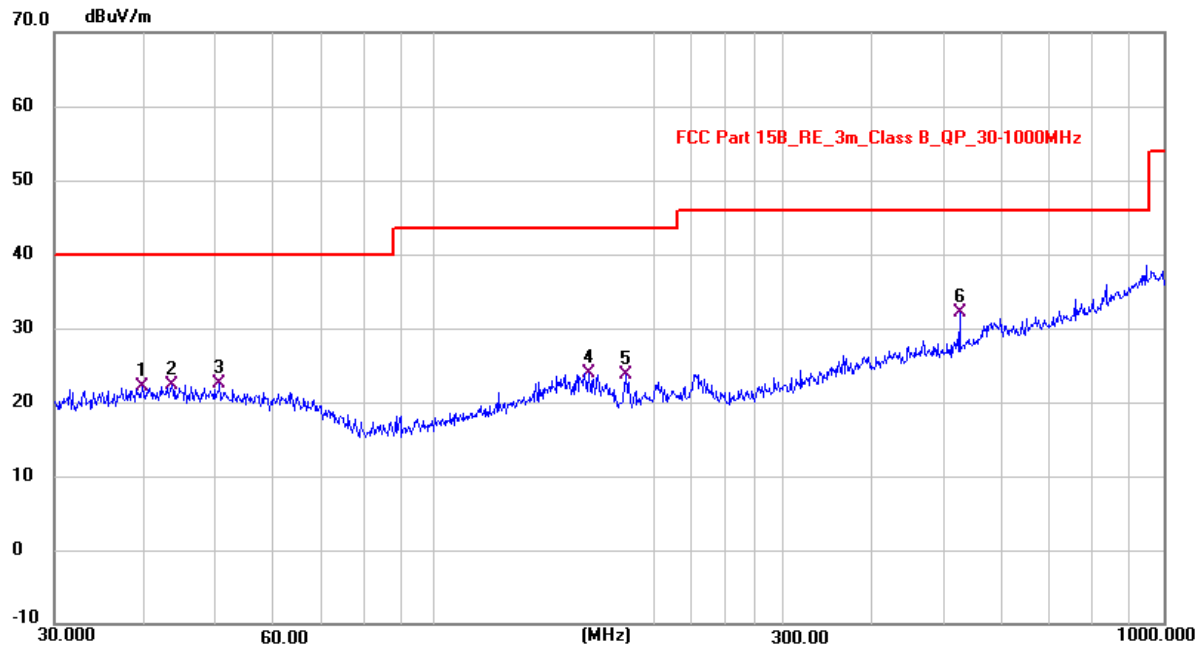

| No. | Frequency (MHz) | Reading (dBuV) | Factor (dB/m) | Level (dBuV/m) | Limit (dBuV/m) | Margin (dB) | Detector |
|-----|-----------------|----------------|---------------|----------------|----------------|-------------|----------|
| 1 | 39.6625 | 8.49 | 13.59 | 22.08 | 40.00 | -17.92 | QP |
| 2 | 43.6584 | 8.79 | 13.49 | 22.28 | 40.00 | -17.72 | QP |
| 3 | 50.6970 | 9.39 | 13.12 | 22.51 | 40.00 | -17.49 | QP |
| 4 | 162.7532 | 11.00 | 12.98 | 23.98 | 43.50 | -19.52 | QP |
| 5 | 182.8796 | 12.55 | 11.10 | 23.65 | 43.50 | -19.85 | QP |
| 6 * | 525.0142 | 13.25 | 18.89 | 32.14 | 46.00 | -13.86 | QP |

Note: Level = Reading + Factor Margin = Level - Limit

| | |
|----------------------------|---|
| From 1GHz to 25GHz: | |
| Test Date : 2025.05.26 | Temperature : 26°C |
| Test Engineer : Felix Pang | Humidity : 54% |
| Test Mode : GFSK mode | |
| Test Results : PASS | |
| Note: | <ol style="list-style-type: none">1. The test results are listed in next pages.2. If the limits for the measurement with the average detector are met when using a receiver with a peak detector, the test unit shall be deemed to meet both limits and the measurement with the average detector and quasi-peak detector need not be carried out.3. If the limits for the measurement with the average detector are met when using a receiver with a quasi-peak detector, the test unit shall be deemed to meet both limits and the measurement with the average detector need not be carried out. |

1Mbps:

| Test Mode : GFSK TX Low | | | | | | | | |
|--------------------------|--|----------|------------------|----------------|-----------------|----------------|--------|--------|
| No. | Freq MHz | Polarity | Reading (dBuV/m) | Correct Factor | Result (dBuV/m) | Limit (dBuV/m) | Margin | Remark |
| 1 | 4804 | V | 83.59 | -13.25 | 70.34 | 74.00 | -3.66 | Peak |
| 2 | 4804 | V | 59.08 | -13.25 | 45.83 | 54.00 | -8.17 | Avg |
| 3 | 7206 | -- | -- | -- | -- | -- | -- | -- |
| 4 | 9608 | -- | -- | -- | -- | -- | -- | -- |
| 5 | 4804 | H | 77.12 | -13.25 | 63.87 | 74.00 | -10.13 | Peak |
| 6 | 4804 | H | 58.59 | -13.25 | 45.34 | 54.00 | -8.66 | Avg |
| 7 | 7206 | -- | -- | -- | -- | -- | -- | -- |
| 8 | 9608 | -- | -- | -- | -- | -- | -- | -- |
| Test Mode : GFSK TX Mid | | | | | | | | |
| 1 | 4880 | V | 83.26 | -12.98 | 70.28 | 74.00 | -3.72 | Peak |
| 2 | 4880 | V | 62.78 | -12.98 | 49.80 | 54.00 | -4.20 | Avg |
| 3 | 7320 | -- | -- | -- | -- | -- | -- | -- |
| 4 | 9760 | -- | -- | -- | -- | -- | -- | -- |
| 5 | 4880 | H | 80.55 | -12.98 | 67.57 | 74.00 | -6.43 | Peak |
| 6 | 4880 | H | 61.91 | -12.98 | 48.93 | 54.00 | -5.07 | Avg |
| 7 | 7320 | -- | -- | -- | -- | -- | -- | -- |
| 8 | 9760 | -- | -- | -- | -- | -- | -- | -- |
| Test Mode : GFSK TX High | | | | | | | | |
| 1 | 4960 | V | 80.80 | -12.70 | 68.10 | 74.00 | -5.90 | Peak |
| 2 | 4960 | V | 62.44 | -12.70 | 49.74 | 54.00 | -4.26 | Avg |
| 3 | 7440 | -- | -- | -- | -- | -- | -- | -- |
| 4 | 9920 | -- | -- | -- | -- | -- | -- | -- |
| 5 | 4960 | H | 77.98 | -12.70 | 65.28 | 74.00 | -8.72 | Peak |
| 6 | 4960 | H | 59.36 | -12.70 | 46.66 | 54.00 | -7.34 | Avg |
| 7 | 7440 | -- | -- | -- | -- | -- | -- | -- |
| 8 | 9920 | -- | -- | -- | -- | -- | -- | -- |
| Note: | 1. Means other frequency and mode comply with standard requirements and at least have 20dB margin. 2. Correct Factor=Cable Loss+ Antenna Factor-Amplifier Gain. Result=Reading + Correct Factor. Margin= Result-Limit. | | | | | | | |

2Mbps:

| Test Mode : GFSK TX Low | | | | | | | | |
|--------------------------|--|----------|------------------|----------------|-----------------|----------------|--------|--------|
| No. | Freq MHz | Polarity | Reading (dBuV/m) | Correct Factor | Result (dBuV/m) | Limit (dBuV/m) | Margin | Remark |
| 1 | 4804 | V | 82.30 | -13.25 | 69.05 | 74.00 | -4.95 | Peak |
| 2 | 4804 | V | 59.51 | -13.25 | 46.26 | 54.00 | -7.74 | Avg |
| 3 | 7206 | -- | -- | -- | -- | -- | -- | -- |
| 4 | 9608 | -- | -- | -- | -- | -- | -- | -- |
| 5 | 4804 | H | 79.70 | -13.25 | 66.45 | 74.00 | -7.55 | Peak |
| 6 | 4804 | H | 58.78 | -13.25 | 45.53 | 54.00 | -8.47 | Avg |
| 7 | 7206 | -- | -- | -- | -- | -- | -- | -- |
| 8 | 9608 | -- | -- | -- | -- | -- | -- | -- |
| Test Mode : GFSK TX Mid | | | | | | | | |
| 1 | 4880 | V | 82.28 | -12.98 | 69.30 | 74.00 | -4.70 | Peak |
| 2 | 4880 | V | 61.72 | -12.98 | 48.74 | 54.00 | -5.26 | Avg |
| 3 | 7320 | -- | -- | -- | -- | -- | -- | -- |
| 4 | 9760 | -- | -- | -- | -- | -- | -- | -- |
| 5 | 4880 | H | 82.76 | -12.98 | 69.78 | 74.00 | -4.22 | Peak |
| 6 | 4880 | H | 60.38 | -12.98 | 47.40 | 54.00 | -6.60 | Avg |
| 7 | 7320 | -- | -- | -- | -- | -- | -- | -- |
| 8 | 9760 | -- | -- | -- | -- | -- | -- | -- |
| Test Mode : GFSK TX High | | | | | | | | |
| 1 | 4960 | V | 80.82 | -12.70 | 68.12 | 74.00 | -5.88 | Peak |
| 2 | 4960 | V | 61.81 | -12.70 | 49.11 | 54.00 | -4.89 | Avg |
| 3 | 7440 | -- | -- | -- | -- | -- | -- | -- |
| 4 | 9920 | -- | -- | -- | -- | -- | -- | -- |
| 5 | 4960 | H | 80.83 | -12.70 | 68.13 | 74.00 | -5.87 | Peak |
| 6 | 4960 | H | 59.52 | -12.70 | 46.82 | 54.00 | -7.18 | Avg |
| 7 | 7440 | -- | -- | -- | -- | -- | -- | -- |
| 8 | 9920 | -- | -- | -- | -- | -- | -- | -- |
| Note: | 1. Means other frequency and mode comply with standard requirements and at least have 20dB margin. 2. Correct Factor=Cable Loss+ Antenna Factor-Amplifier Gain. Result=Reading + Correct Factor. Margin= Result-Limit. | | | | | | | |

4. Power Line Conducted Emission

4.1. Test Limits

| Frequency MHz | Limits dB(μ V) | |
|------------------|---------------------|---------------|
| | Quasi-peak Level | Average Level |
| 0.15 -0.50 | 66 -56* | 56 - 46* |
| 0.50 -5.00 | 56 | 46 |
| 5.00 -30.00 | 60 | 50 |

Notes: 1. *Decreasing linearly with logarithm of frequency.

2. The lower limit shall apply at the transition frequencies.

3. The limit decreases in line with the logarithm of the frequency in the range of 0.15 to 0.50 MHz.

4.2. Test Procedure

The EUT is put on the plane 0.8m high above the ground by insulating support and is connected to the power mains through a line impedance stabilization network (L.I.S.N.). This provides a 50ohm coupling impedance for the EUT system. Please refer the block diagram of the test setup and photographs.

Both sides of AC lines are checked to find out the maximum conducted emission. In order to find the maximum emission levels, the relative positions of equipment and all of the interface cables shall be changed according to ANSI C63.10:2013 on Conducted Emission Measurement.

The bandwidth of test receiver is set at 9 kHz.

4.3. Test Setup

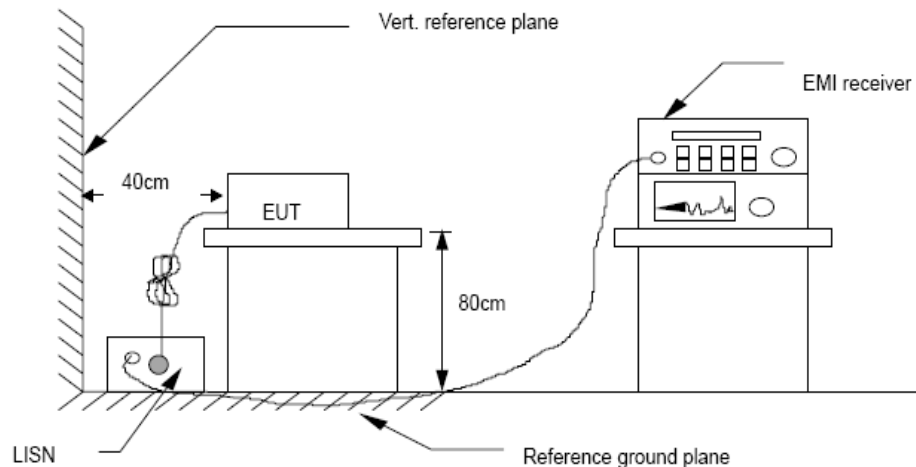

4.4. Test Results

| | | | |
|---------------|---|-------------|--------|
| Test Date | : 2025.05.26 | Temperature | : 26°C |
| Test Engineer | : Felix Pang | Humidity | : 54% |
| Test voltage | : 120V/60Hz | | |
| Test Mode | : GFSK mode | | |
| Test Results | : PASS | | |
| Note: | <ol style="list-style-type: none"> 1. The test results are listed in next pages. 2. If the limits for the measurement with the average detector are met when using a receiver with a peak detector, the test unit shall be deemed to meet both limits and the measurement with the average detector and quasi-peak detector need not be carried out. 3. If the limits for the measurement with the average detector are met when using a receiver with a quasi-peak detector, the test unit shall be deemed to meet both limits and the measurement with the average detector need not be carried out. 4. All modes have been tested, and only worst data of 1Mbps GFSK 2402MHz mode was listed in this report. | | |

Polarization: L

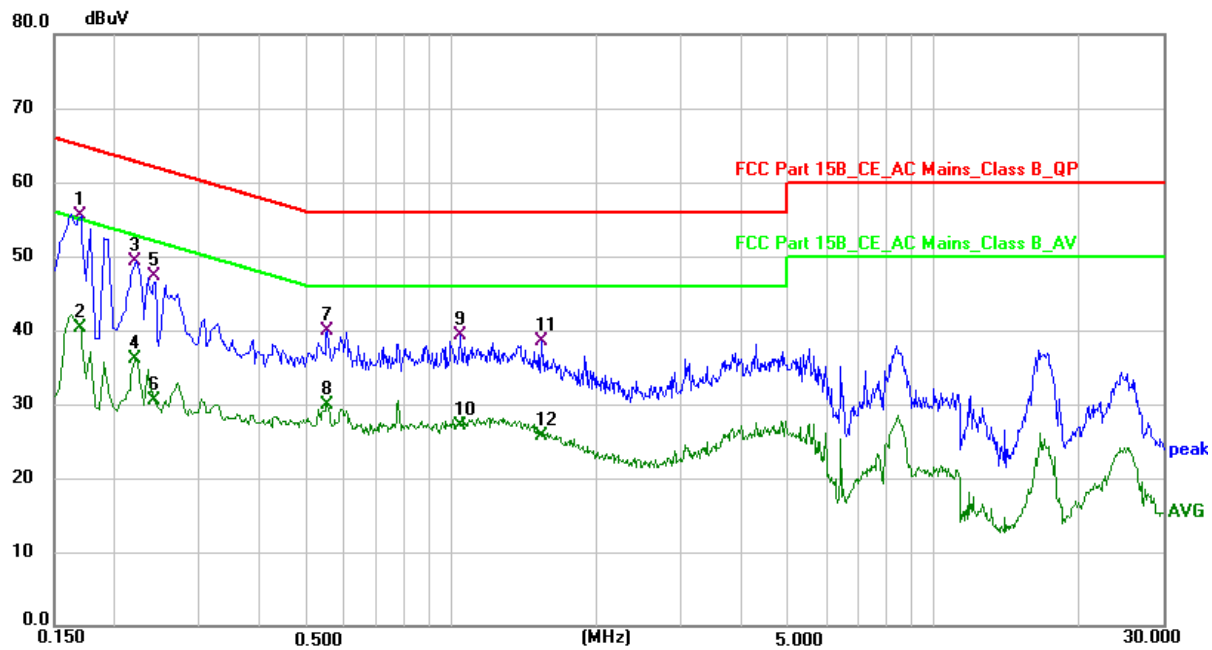

| No. | Frequency (MHz) | Reading (dBuV) | Factor (dB) | Level (dBuV) | Limit (dBuV) | Margin (dB) | Detector | P/F |
|-----|-----------------|----------------|-------------|--------------|--------------|-------------|----------|-----|
| 1 * | 0.1700 | 45.57 | 9.94 | 55.51 | 64.96 | -9.45 | QP | P |
| 2 | 0.1700 | 30.44 | 9.94 | 40.38 | 54.96 | -14.58 | AVG | P |
| 3 | 0.2220 | 39.30 | 9.96 | 49.26 | 62.74 | -13.48 | QP | P |
| 4 | 0.2220 | 26.07 | 9.96 | 36.03 | 52.74 | -16.71 | AVG | P |
| 5 | 0.2420 | 37.27 | 9.97 | 47.24 | 62.03 | -14.79 | QP | P |
| 6 | 0.2420 | 20.54 | 9.97 | 30.51 | 52.03 | -21.52 | AVG | P |
| 7 | 0.5540 | 30.10 | 9.78 | 39.88 | 56.00 | -16.12 | QP | P |
| 8 | 0.5540 | 20.09 | 9.78 | 29.87 | 46.00 | -16.13 | AVG | P |
| 9 | 1.0460 | 29.93 | 9.41 | 39.34 | 56.00 | -16.66 | QP | P |
| 10 | 1.0460 | 17.66 | 9.41 | 27.07 | 46.00 | -18.93 | AVG | P |
| 11 | 1.5420 | 29.16 | 9.40 | 38.56 | 56.00 | -17.44 | QP | P |
| 12 | 1.5420 | 16.29 | 9.40 | 25.69 | 46.00 | -20.31 | AVG | P |

Note: Level = Reading + Factor Margin = Level - Limit

Polarization: N

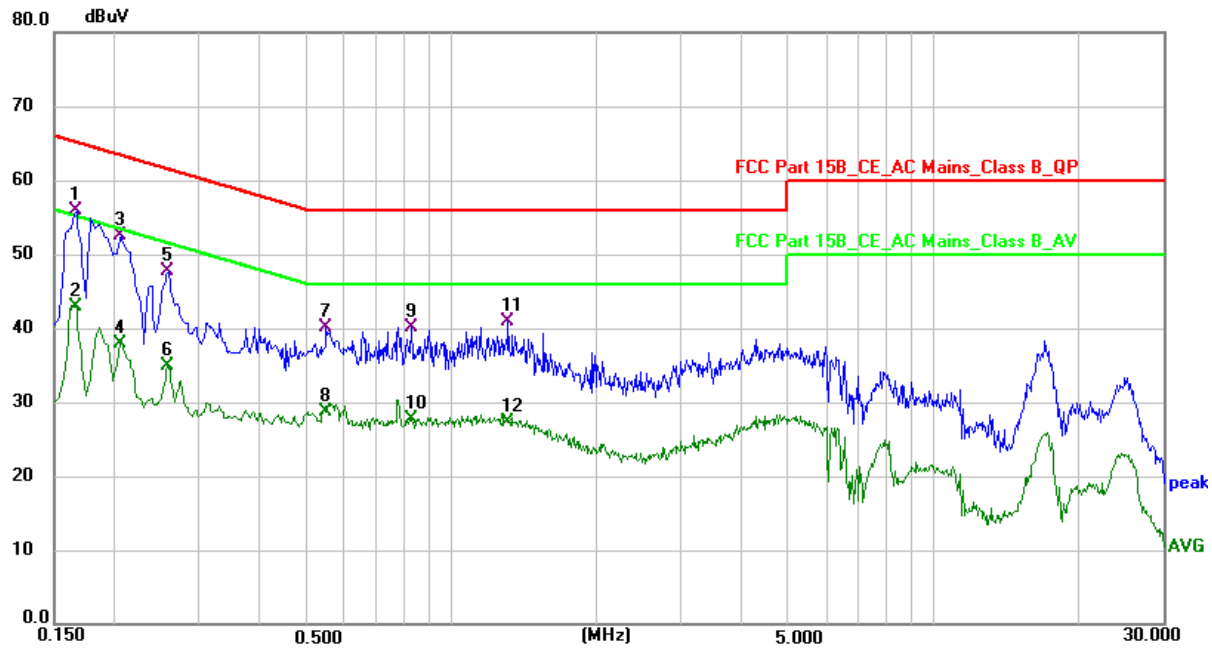

| No. | Frequency (MHz) | Reading (dBuV) | Factor (dB) | Level (dBuV) | Limit (dBuV) | Margin (dB) | Detector | P/F |
|-----|-----------------|----------------|-------------|--------------|--------------|-------------|----------|-----|
| 1 * | 0.1660 | 45.97 | 9.86 | 55.83 | 65.16 | -9.33 | QP | P |
| 2 | 0.1660 | 33.06 | 9.86 | 42.92 | 55.16 | -12.24 | AVG | P |
| 3 | 0.2060 | 42.57 | 10.03 | 52.60 | 63.37 | -10.77 | QP | P |
| 4 | 0.2060 | 27.85 | 10.03 | 37.88 | 53.37 | -15.49 | AVG | P |
| 5 | 0.2580 | 37.81 | 9.89 | 47.70 | 61.50 | -13.80 | QP | P |
| 6 | 0.2580 | 24.95 | 9.89 | 34.84 | 51.50 | -16.66 | AVG | P |
| 7 | 0.5500 | 30.41 | 9.78 | 40.19 | 56.00 | -15.81 | QP | P |
| 8 | 0.5500 | 18.99 | 9.78 | 28.77 | 46.00 | -17.23 | AVG | P |
| 9 | 0.8300 | 30.45 | 9.66 | 40.11 | 56.00 | -15.89 | QP | P |
| 10 | 0.8300 | 18.06 | 9.66 | 27.72 | 46.00 | -18.28 | AVG | P |
| 11 | 1.3140 | 31.56 | 9.43 | 40.99 | 56.00 | -15.01 | QP | P |
| 12 | 1.3140 | 17.96 | 9.43 | 27.39 | 46.00 | -18.61 | AVG | P |

Note: Level = Reading + Factor Margin = Level - Limit

5. Out-of-band Emissions

5.1. Test Limits

In any 100 kHz bandwidth outside the frequency band in which the spread spectrum or digitally modulated intentional radiator is operating, the radio frequency power that is produced by the intentional radiator shall be at least 20 dB below that in the 100 kHz bandwidth within the band that contains the highest level of the desired power, based on either an RF conducted or a radiated measurement, provided the transmitter demonstrates compliance with the peak conducted power limits. If the transmitter complies with the conducted power limits based on the use of RMS averaging over a time interval, as permitted under paragraph (b)(3) of this section, the attenuation required under this paragraph shall be 30 dB instead of 20 dB. Attenuation below the general limits specified in FCC Part 15.209(a) is not required. Please refer section RSS-GEN&15.247.

5.2. Test Procedure

Connect the transmitter output to spectrum analyzer using a low loss RF cable, and set the spectrum analyzer to RBW=100 kHz, VBW= 300 kHz, peak detector, and max hold. Measurements utilizing these settings are made of the in-band reference level, band edge and out-of-band emissions.

5.3. Test Setup

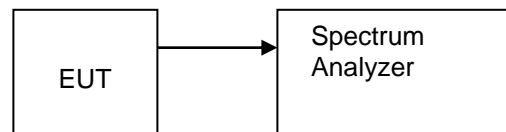

5.4. Test Results

PASS.

The test results are listed in next pages.

Band edge: Pass

| Condition | Antenna | Modulation | TX_Frequency (MHz) | Max. Mark_freq(MHz) | Ref_level(dBm) | Spurious level(dBm) | limit(dBm) | Result |
|-----------|---------|------------|--------------------|---------------------|----------------|---------------------|------------|--------|
| NVNT | ANT1 | 1Mbps | 2402.00 | 2338.120 | -3.560 | -49.212 | -23.560 | Pass |
| NVNT | ANT1 | 1Mbps | 2480.00 | 2498.950 | 3.845 | -50.703 | -16.155 | Pass |
| NVNT | ANT1 | 2Mbps | 2402.00 | 2399.965 | 1.330 | -32.083 | -18.670 | Pass |
| NVNT | ANT1 | 2Mbps | 2480.00 | 2496.850 | 1.564 | -51.764 | -18.436 | Pass |

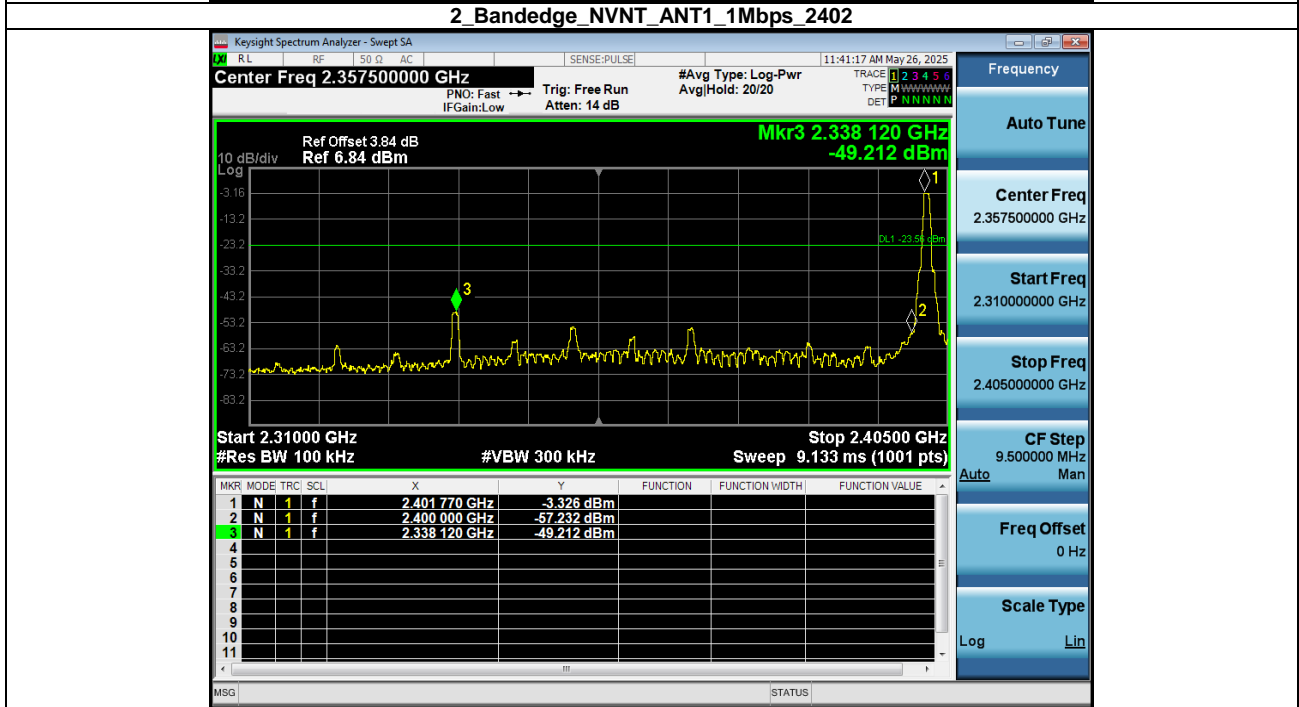
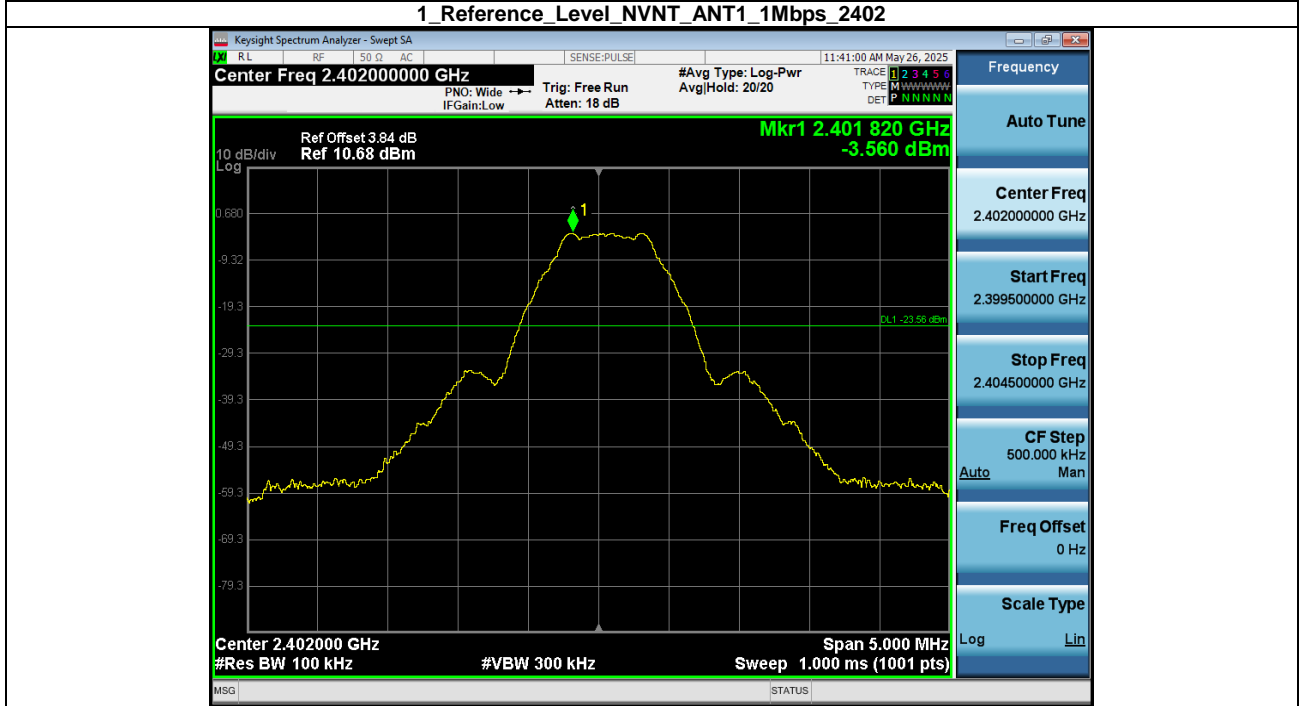

1_Reference_Level_NVNT_ANT1_1Mbps_2480



2_Bandedge_NVNT_ANT1_1Mbps_2480

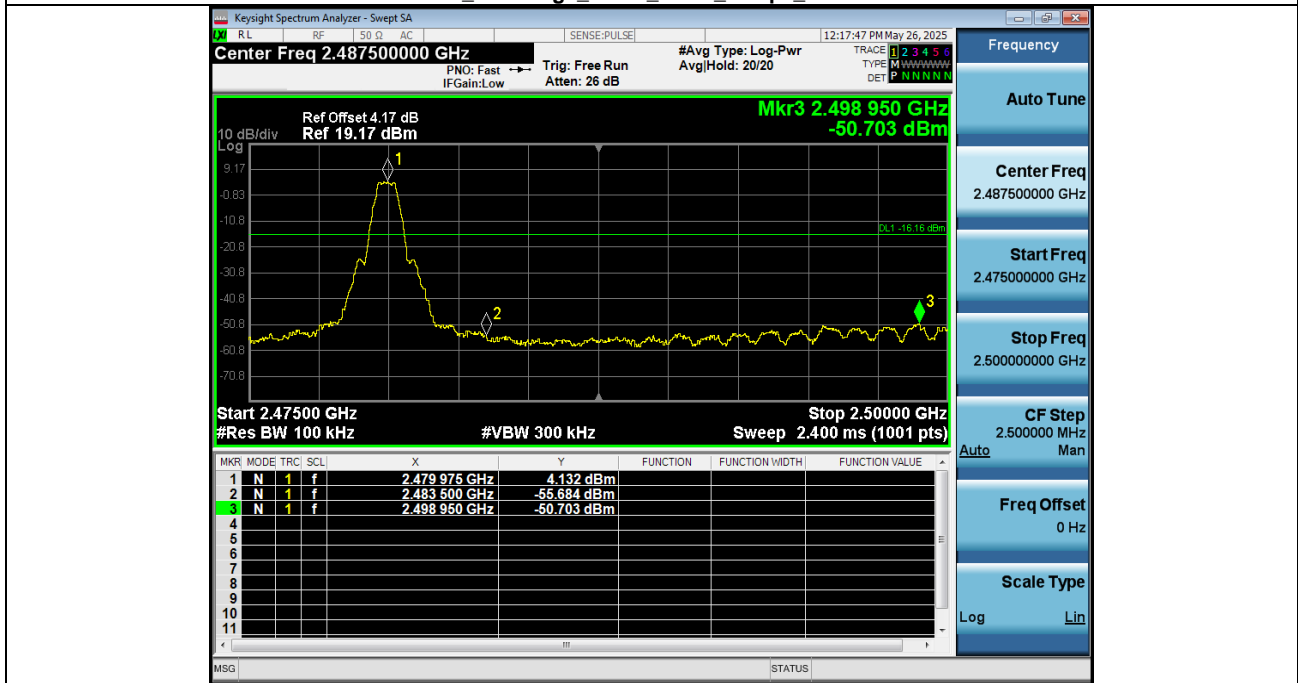

1_Reference_Level_NVNT_ANT1_2Mbps_2402



2_Bandedge_NVNT_ANT1_2Mbps_2402

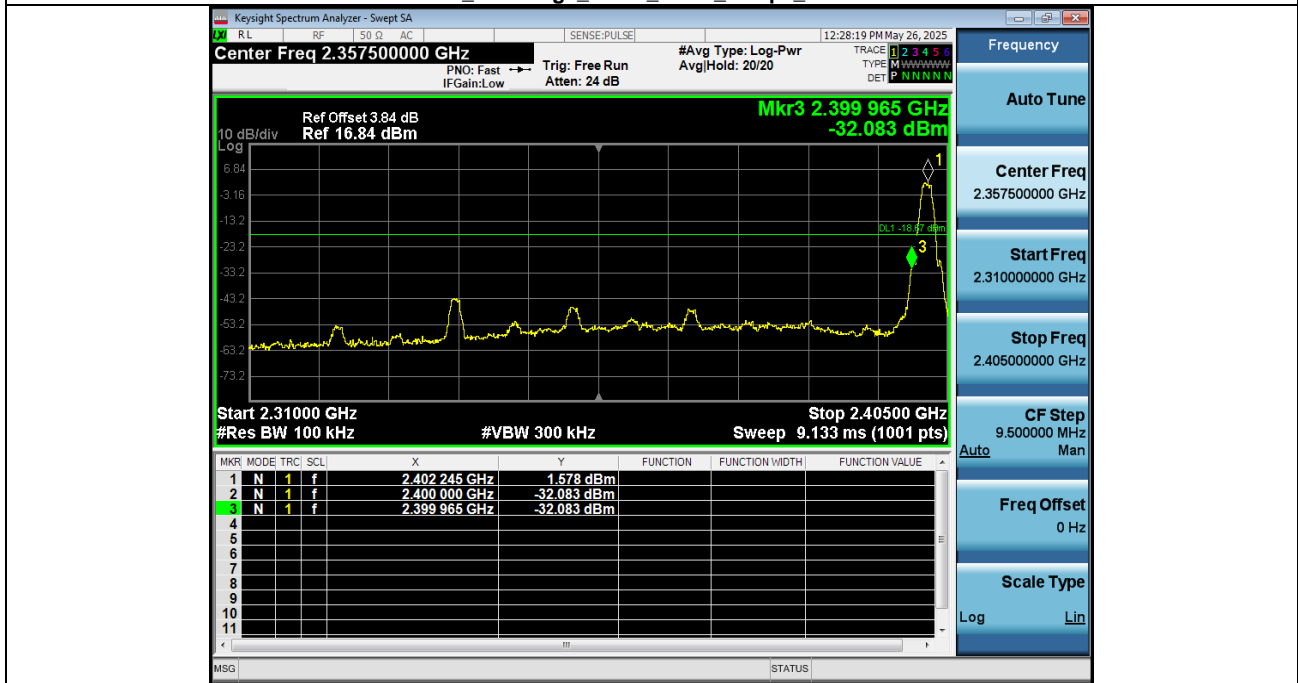

1_Reference_Level_NVNT_ANT1_2Mbps_2480



2_Bandedge_NVNT_ANT1_2Mbps_2480

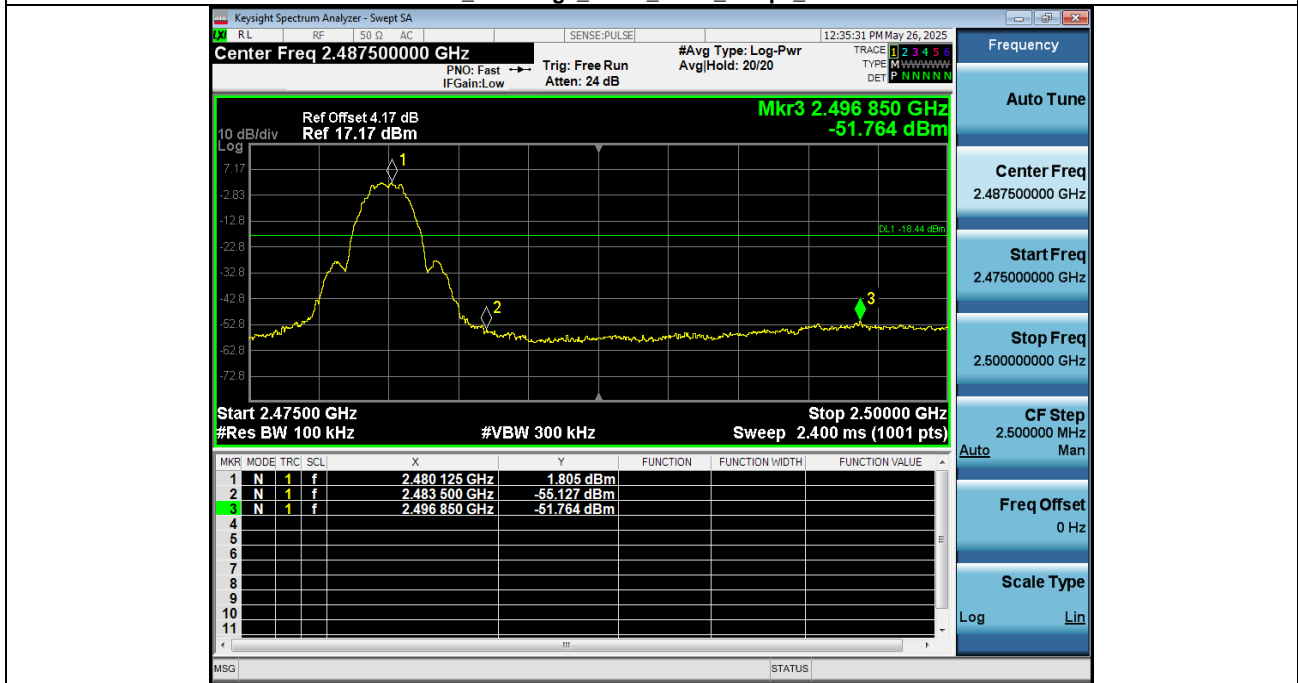

Spurious Emission: Pass

| Condition | Antenna | Modulation | TX_Frequency (MHz) | Ref_level(dBm) | Spurious level(dBm) | limit(dBm) | Result |
|-----------|---------|------------|--------------------|----------------|---------------------|------------|--------|
| NVNT | ANT1 | 1Mbps | 2402.00 | -3.560 | -47.204 | -23.560 | Pass |
| NVNT | ANT1 | 1Mbps | 2440.00 | 3.522 | -38.573 | -16.478 | Pass |
| NVNT | ANT1 | 1Mbps | 2480.00 | 3.845 | -39.474 | -16.155 | Pass |
| NVNT | ANT1 | 2Mbps | 2402.00 | 1.330 | -39.074 | -18.670 | Pass |
| NVNT | ANT1 | 2Mbps | 2440.00 | 1.310 | -40.125 | -18.690 | Pass |
| NVNT | ANT1 | 2Mbps | 2480.00 | 1.564 | -41.135 | -18.436 | Pass |

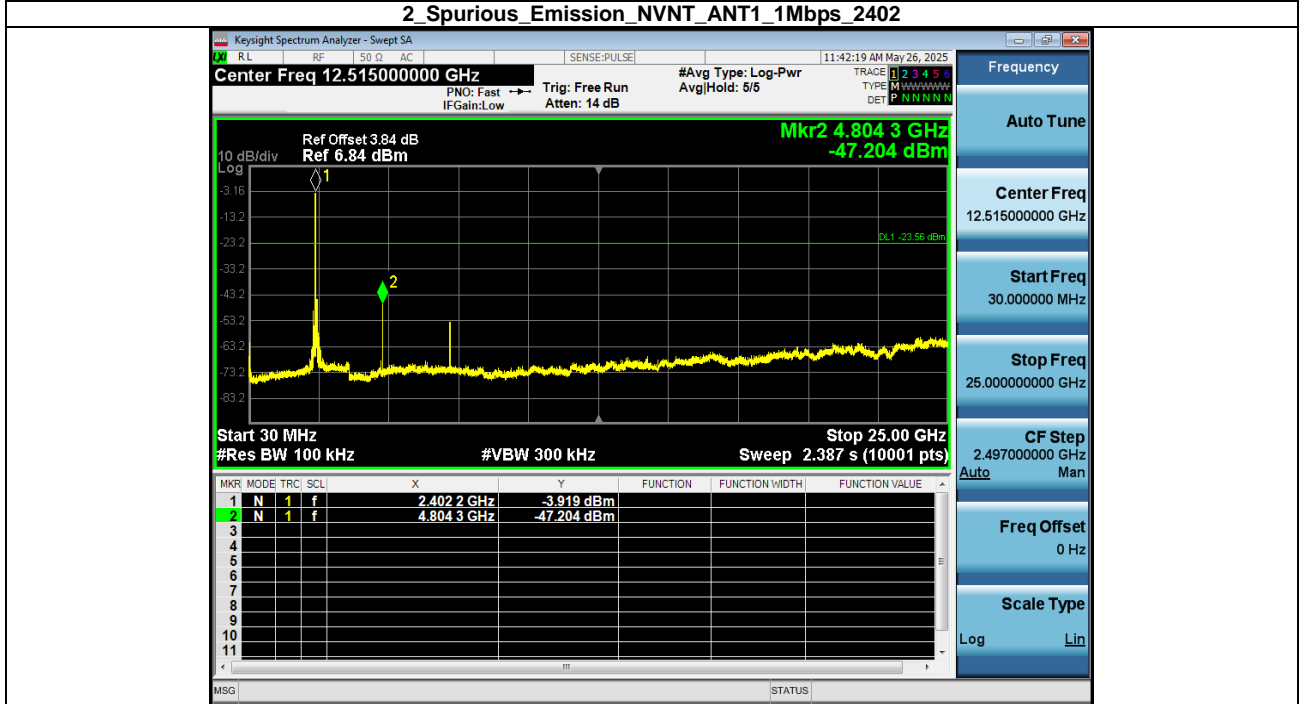
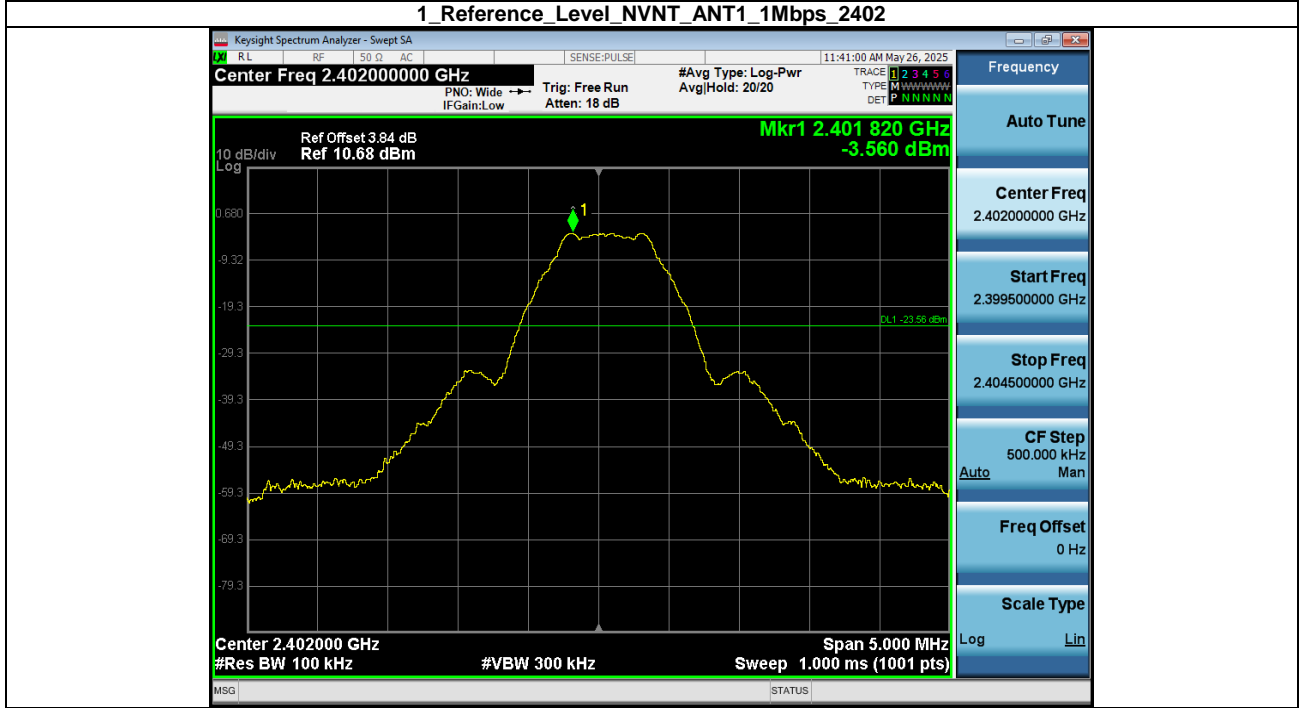

1_Reference_Level_NVNT_ANT1_1Mbps_2440



2_Spurious_Emission_NVNT_ANT1_1Mbps_2440

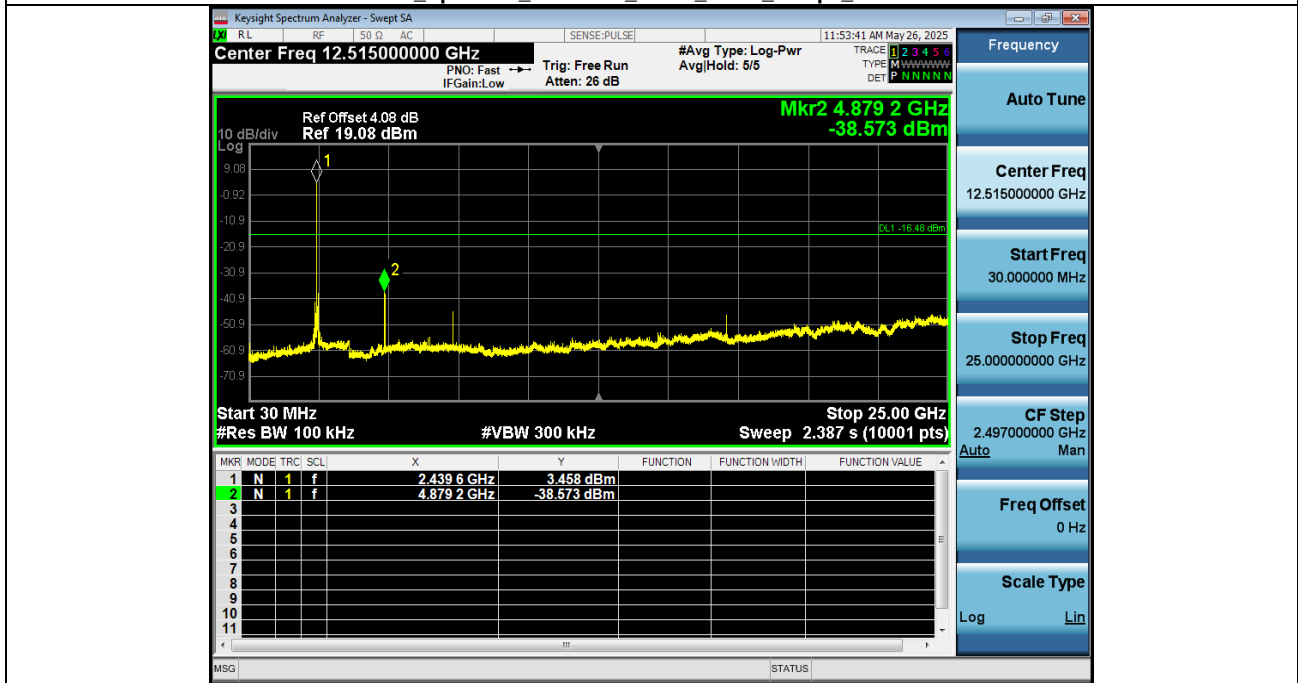

1_Reference_Level_NVNT_ANT1_1Mbps_2480

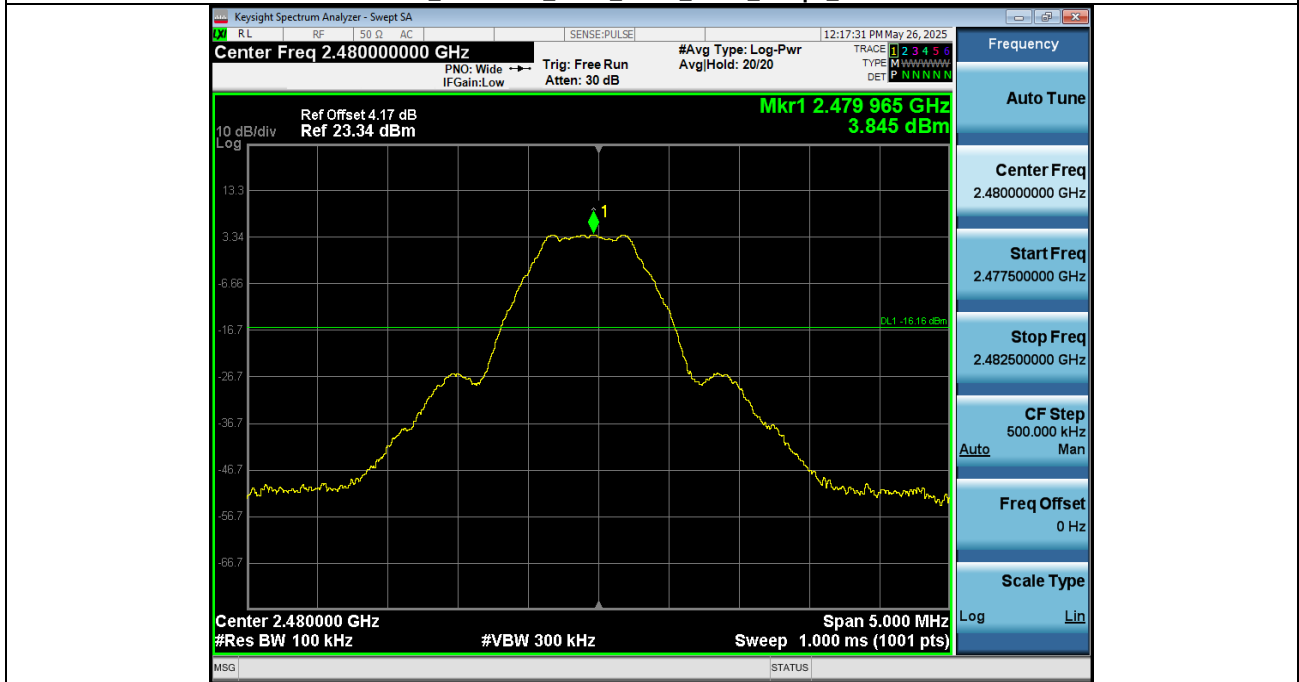

2_Spurious_Emission_NVNT_ANT1_1Mbps_2480

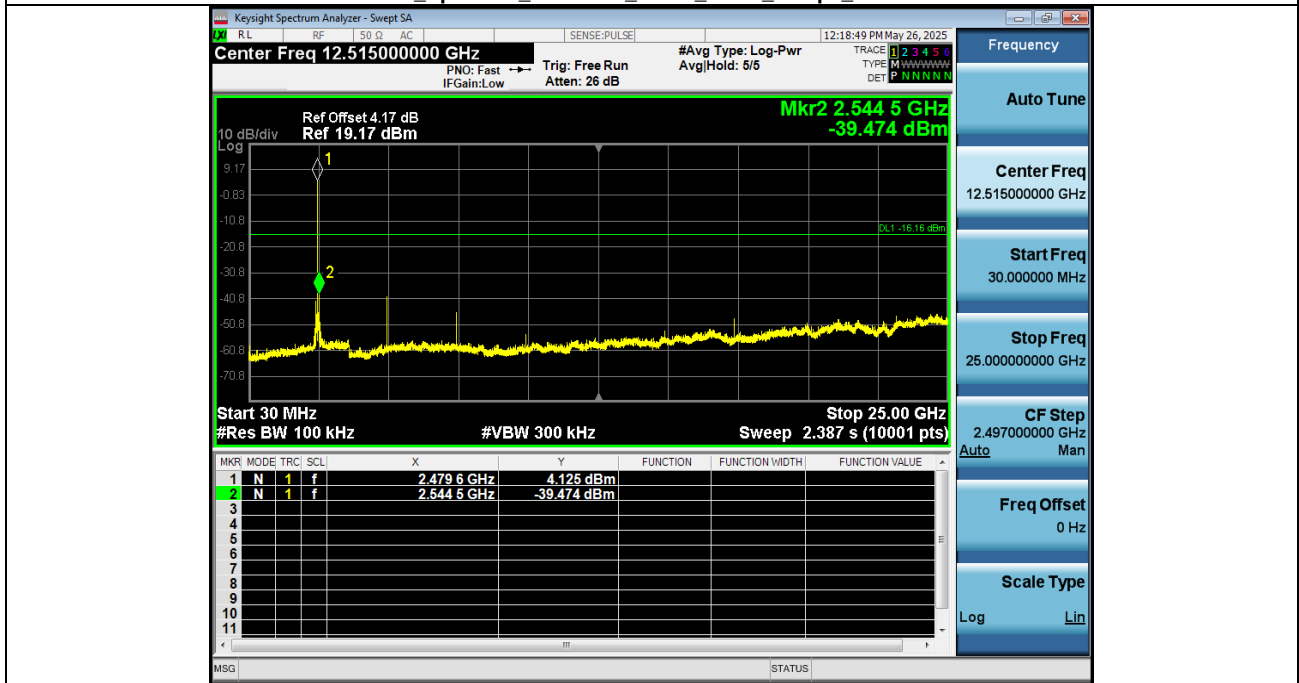

1_Reference_Level_NVNT_ANT1_2Mbps_2402



2_Spurious_Emission_NVNT_ANT1_2Mbps_2402

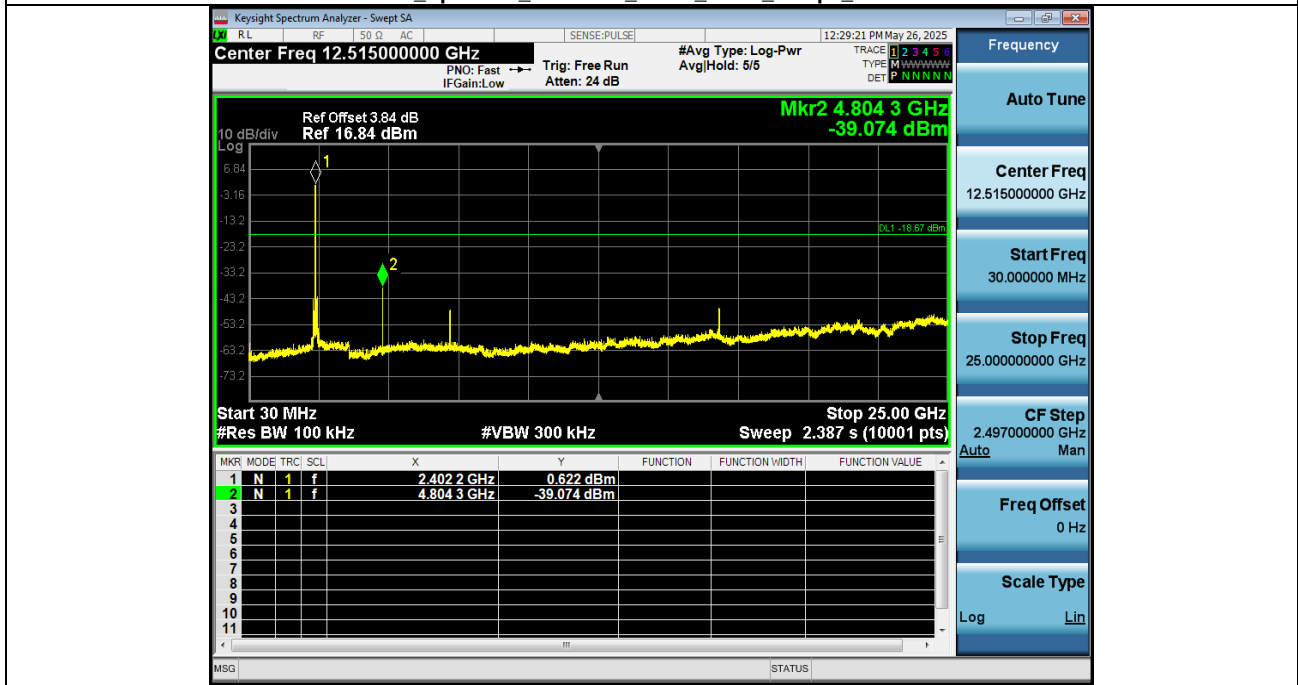

1_Reference_Level_NVNT_ANT1_2Mbps_2440



2_Spurious_Emission_NVNT_ANT1_2Mbps_2440

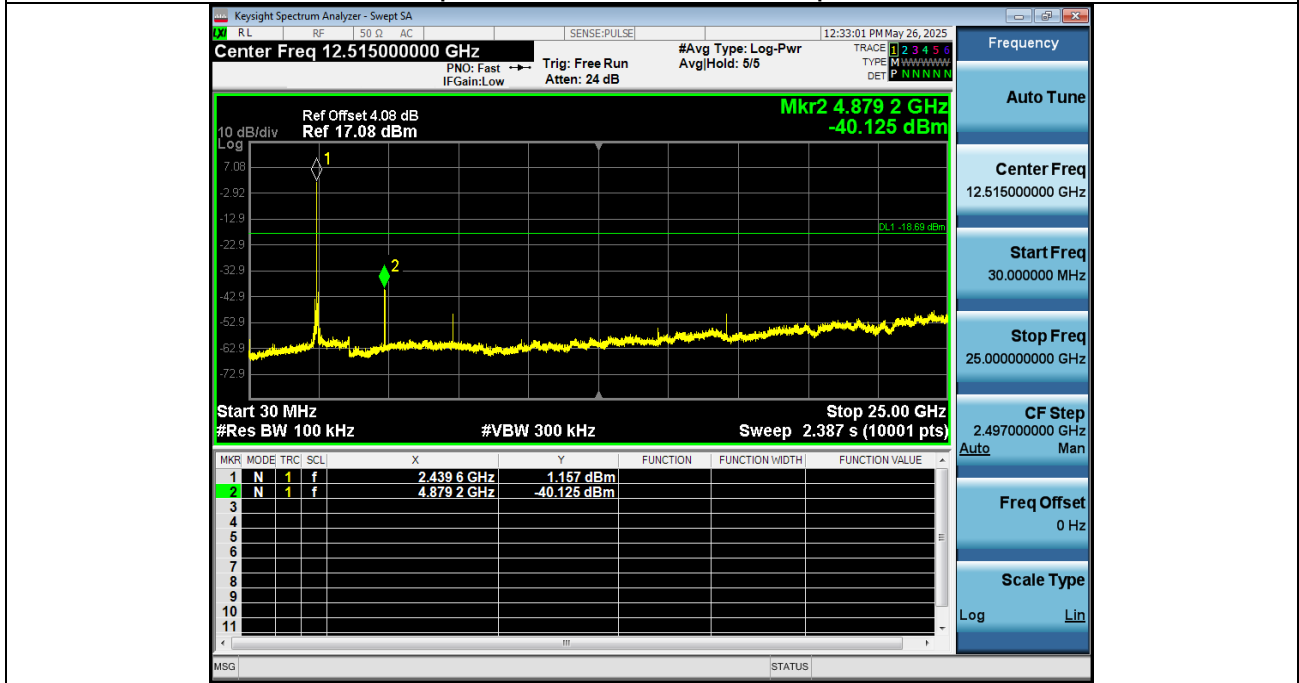

1_Reference_Level_NVNT_ANT1_2Mbps_2480



2_Spurious_Emission_NVNT_ANT1_2Mbps_2480

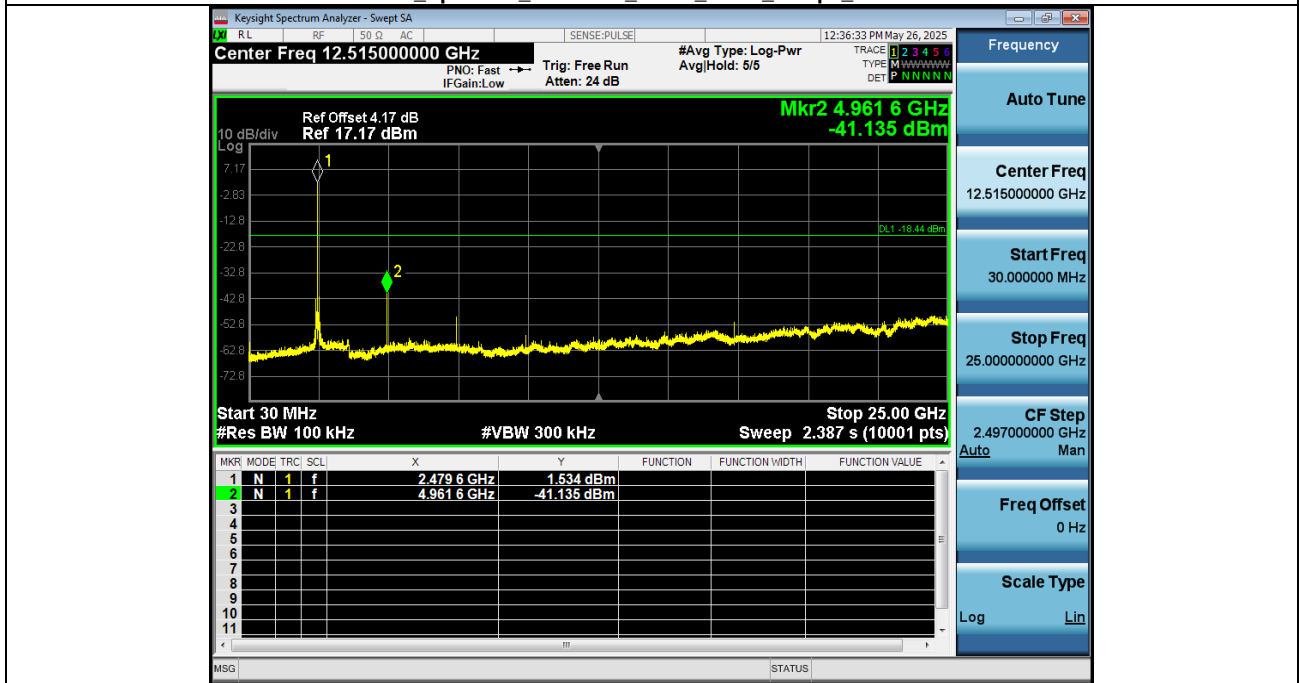

6. Conducted Maximum Output Power

6.1. Test limits

Please refer RSS-247 & FCC PART 15: 15.247.

Regulation 15.247(b) The limit of Maximum Peak Output Power Measurement is 1 W(30dBm)

6.2. Test Procedure

Details see the KDB558074 D01 Meas Guidance v05r02

- 1 Place the EUT on the table and set it in transmitting mode.
- 2 Connected the EUT's antenna port to peak power meter by 20dB attenuator.
- 3 Measure out each mode and each bands Peak output power of EUT.

Note: The cable loss and attenuator loss were offset into measure device as amplitude offset.

6.3. Test Setup

Conducted Power:

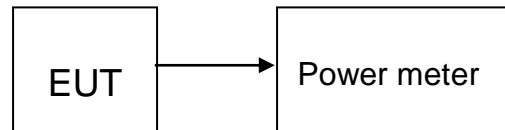

Duty cycle:

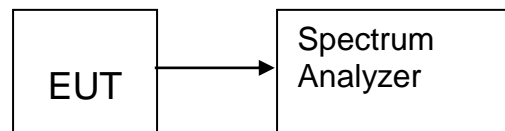

6.4. Test Results

| Condition | Antenna | Rate | Frequency (MHz) | Max. Conducted Power(dBm) | Max. Conducted Power(mW) | Limit(mW) | Result |
|-----------|---------|-------|-----------------|---------------------------|--------------------------|-----------|--------|
| NVNT | ANT1 | 1Mbps | 2402.00 | 4.63 | 2.90 | 1000 | Pass |
| NVNT | ANT1 | 1Mbps | 2440.00 | 4.89 | 3.09 | 1000 | Pass |
| NVNT | ANT1 | 1Mbps | 2480.00 | 5.23 | 3.33 | 1000 | Pass |
| NVNT | ANT1 | 2Mbps | 2402.00 | 4.82 | 3.03 | 1000 | Pass |
| NVNT | ANT1 | 2Mbps | 2440.00 | 5.00 | 3.16 | 1000 | Pass |
| NVNT | ANT1 | 2Mbps | 2480.00 | 5.22 | 3.33 | 1000 | Pass |

| Condition | Antenna | Rate | Frequency (MHz) | Dutycycle(%) | Duty_factor |
|-----------|---------|-------|-----------------|--------------|-------------|
| NVNT | ANT1 | 1Mbps | 2402.00 | 100 | 0.00 |
| NVNT | ANT1 | 1Mbps | 2440.00 | 100 | 0.00 |
| NVNT | ANT1 | 1Mbps | 2480.00 | 100 | 0.00 |
| NVNT | ANT1 | 2Mbps | 2402.00 | 100 | 0.00 |
| NVNT | ANT1 | 2Mbps | 2440.00 | 100 | 0.00 |
| NVNT | ANT1 | 2Mbps | 2480.00 | 100 | 0.00 |

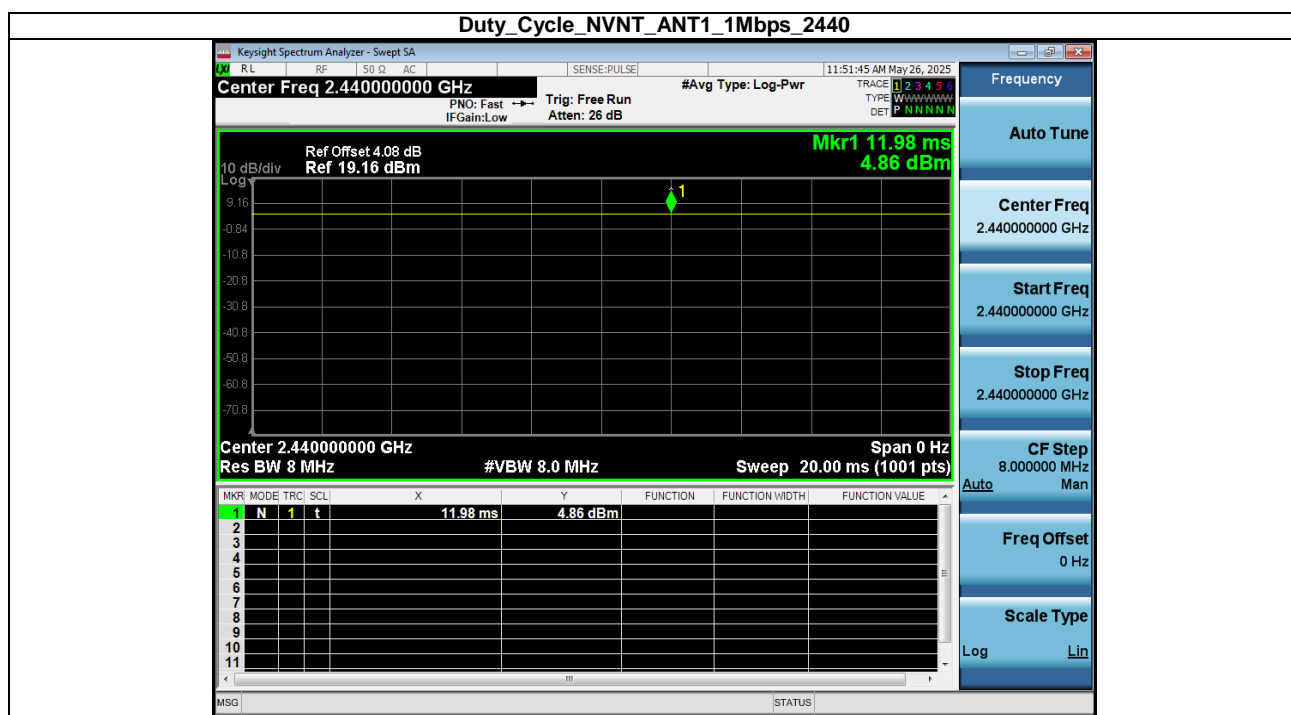
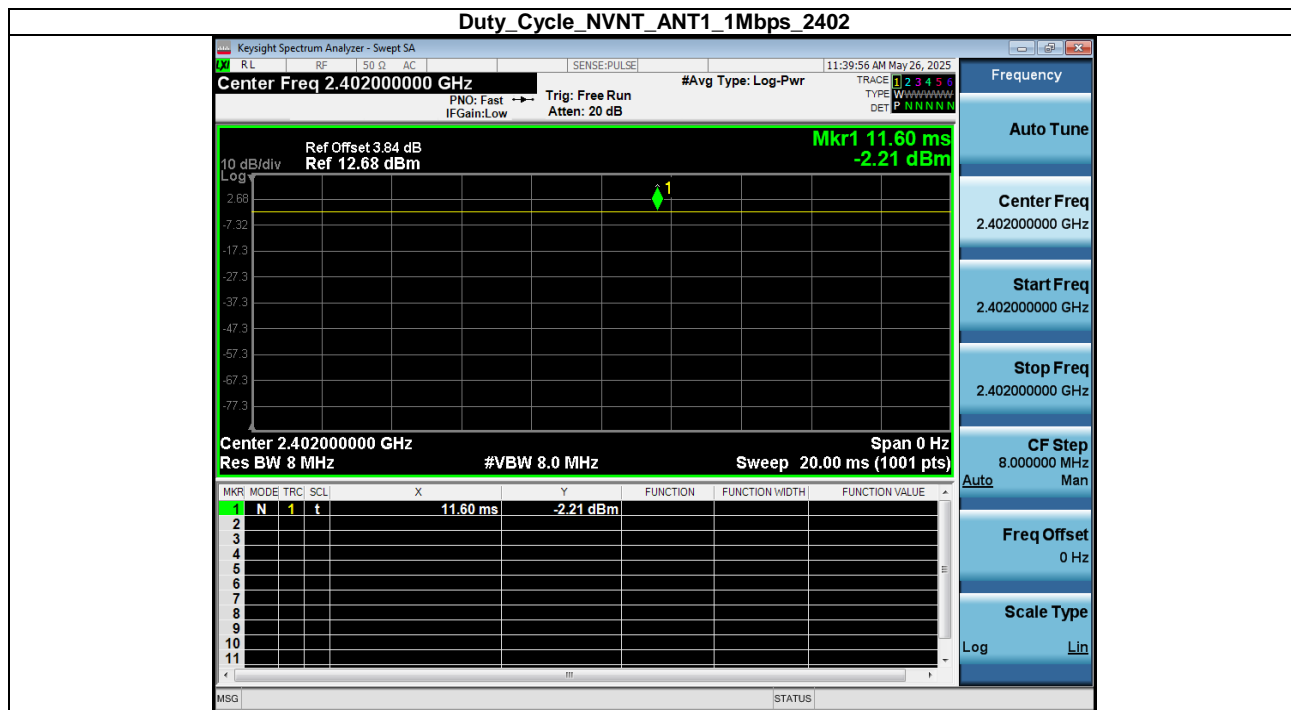

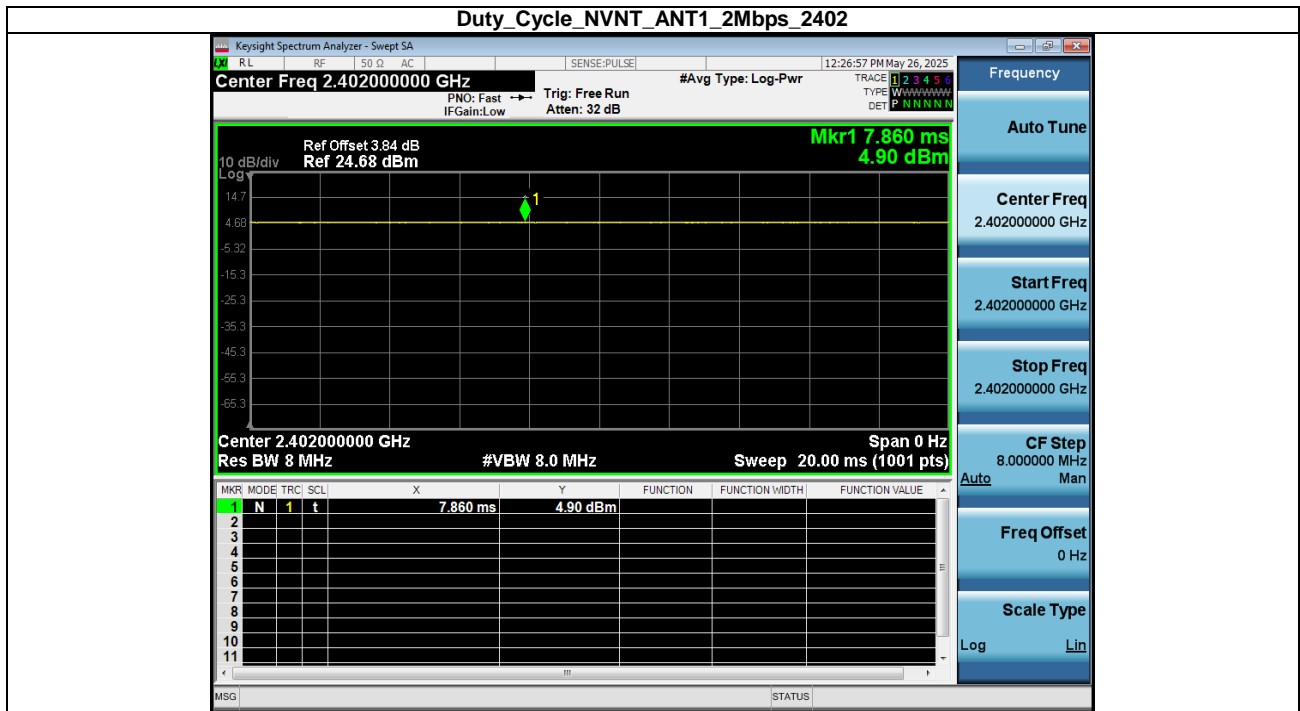
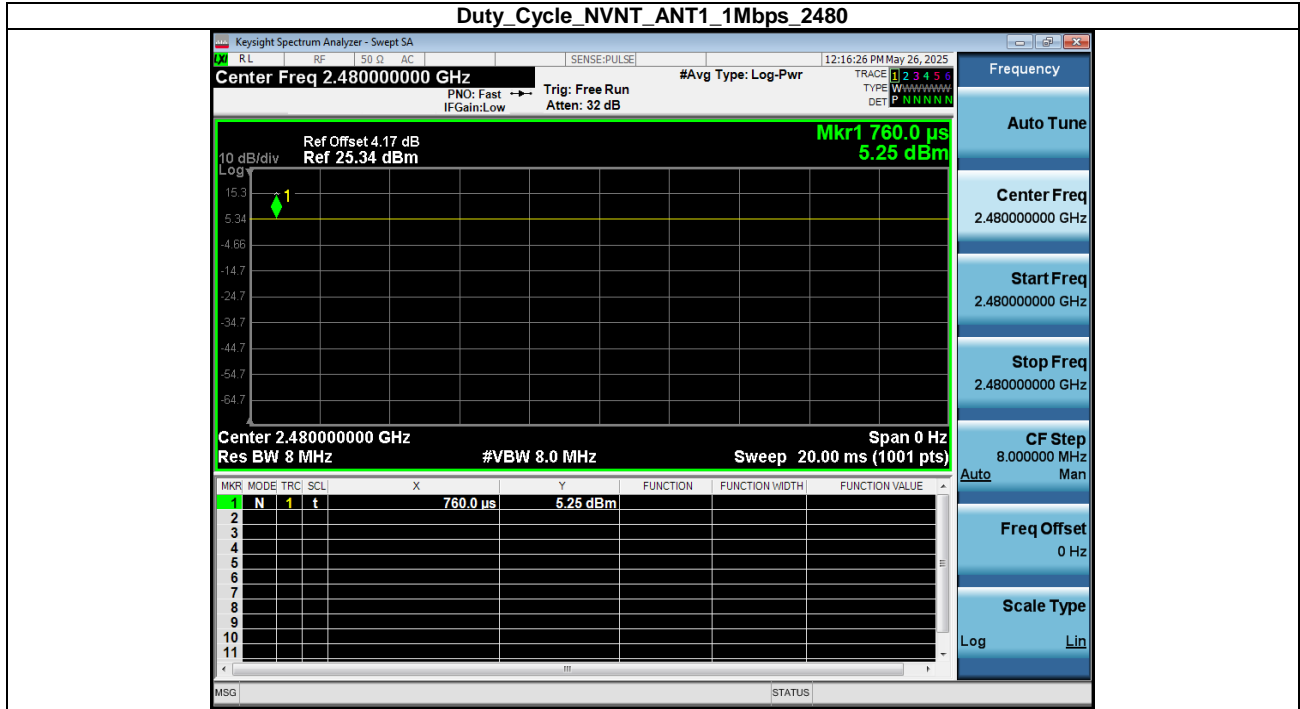

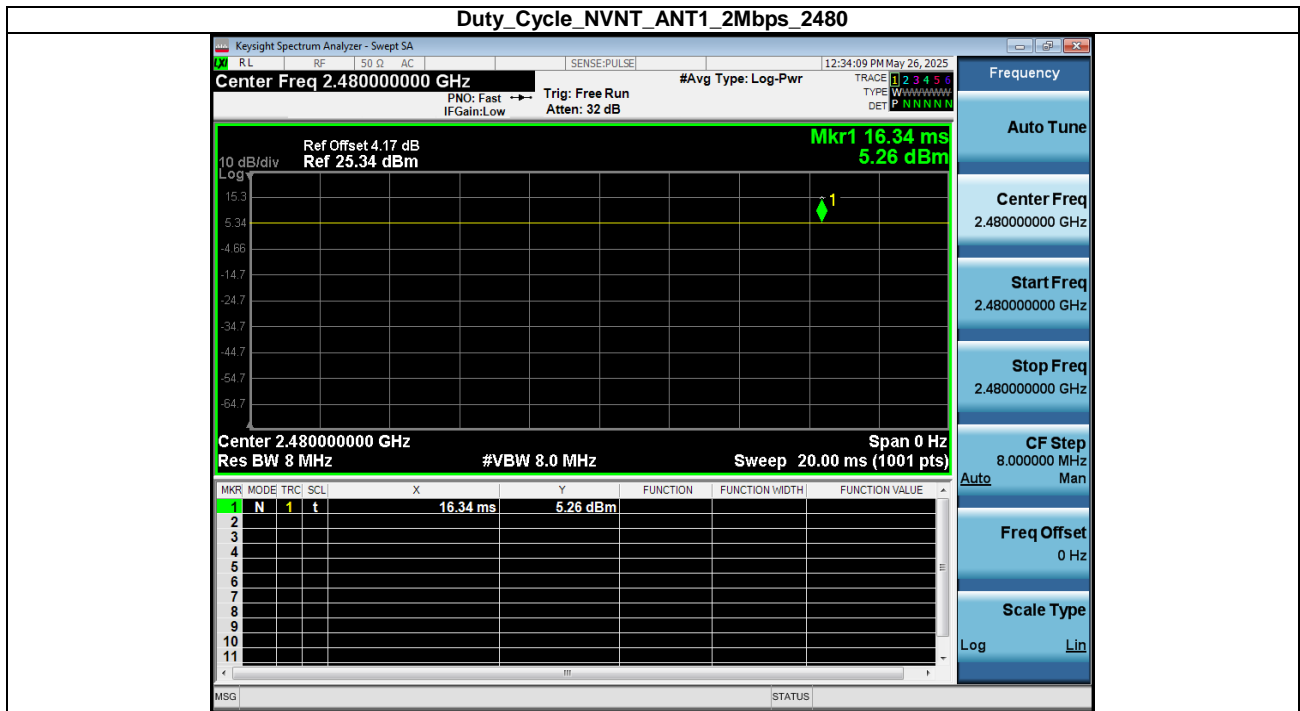
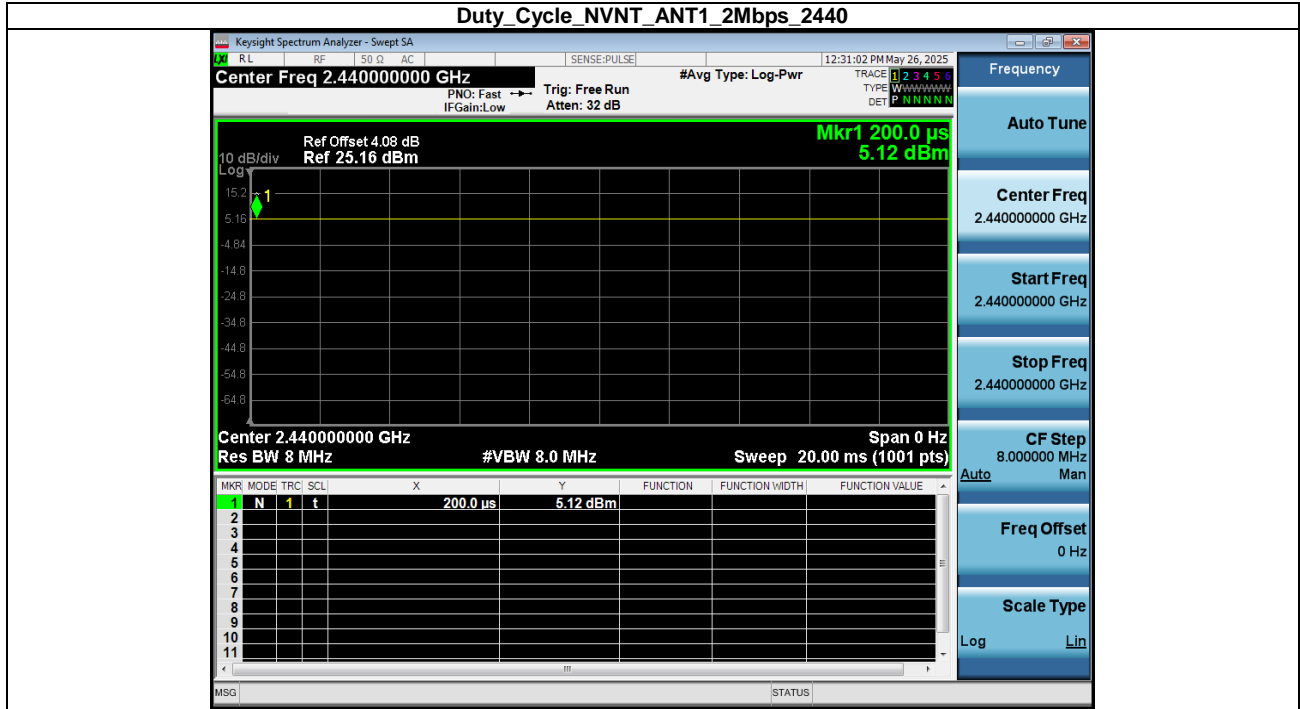

7. Peak Power Spectral Density

7.1. Test limits

- 1 Please refer RSS-247 & FCC PART 15: 15.247.
- 2 For direct sequence systems, the peak power spectral density conducted from the intentional radiator to the antenna shall not be greater than 8dBm in any 3kHz band during any time interval of continuous transmission.
- 3 The direct sequence operating of the hybrid system, with the frequency hopping operation turned off, shall comply with the power density requirements of paragraph (d) of this section.

7.2. Test Procedure

Details see the KDB558074 D01 Meas Guidance v05r02

- 1 Place the EUT on the table and set it in transmitting mode.
- 2 Remove the antenna from the EUT and then connect a low loss RF cable from the antenna port to the spectrum analyzer.
- 3 Set the spectrum analyzer as RBW = 100kHz(Set the RBW to: $3\text{ kHz} \leq \text{RBW} \leq 100\text{ kHz}$.), VBW = 300kHz(Set the VBW $\geq 3 \times \text{RBW}$), span $\geq 1.5 \times \text{DTS bandwidth}$., detail see the test plot.
- 4 Record the max reading.
- 5 Repeat the above procedure until the measurements for all frequencies are completed.

7.3. Test Setup

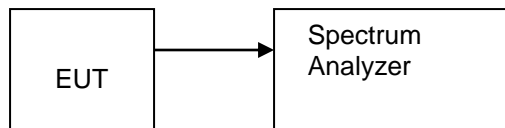

7.4. Test Results

| Condition | Antenna | Rate | Frequency (MHz) | Power Spectral Density(dBm/3kHz) | Limit(dBm/3kHz) | Result |
|-----------|---------|-------|-----------------|----------------------------------|-----------------|--------|
| NVNT | ANT1 | 1Mbps | 2402.00 | -18.74 | 8 | Pass |
| NVNT | ANT1 | 1Mbps | 2440.00 | -11.25 | 8 | Pass |
| NVNT | ANT1 | 1Mbps | 2480.00 | -10.76 | 8 | Pass |
| NVNT | ANT1 | 2Mbps | 2402.00 | -12.94 | 8 | Pass |
| NVNT | ANT1 | 2Mbps | 2440.00 | -12.39 | 8 | Pass |
| NVNT | ANT1 | 2Mbps | 2480.00 | -12.22 | 8 | Pass |

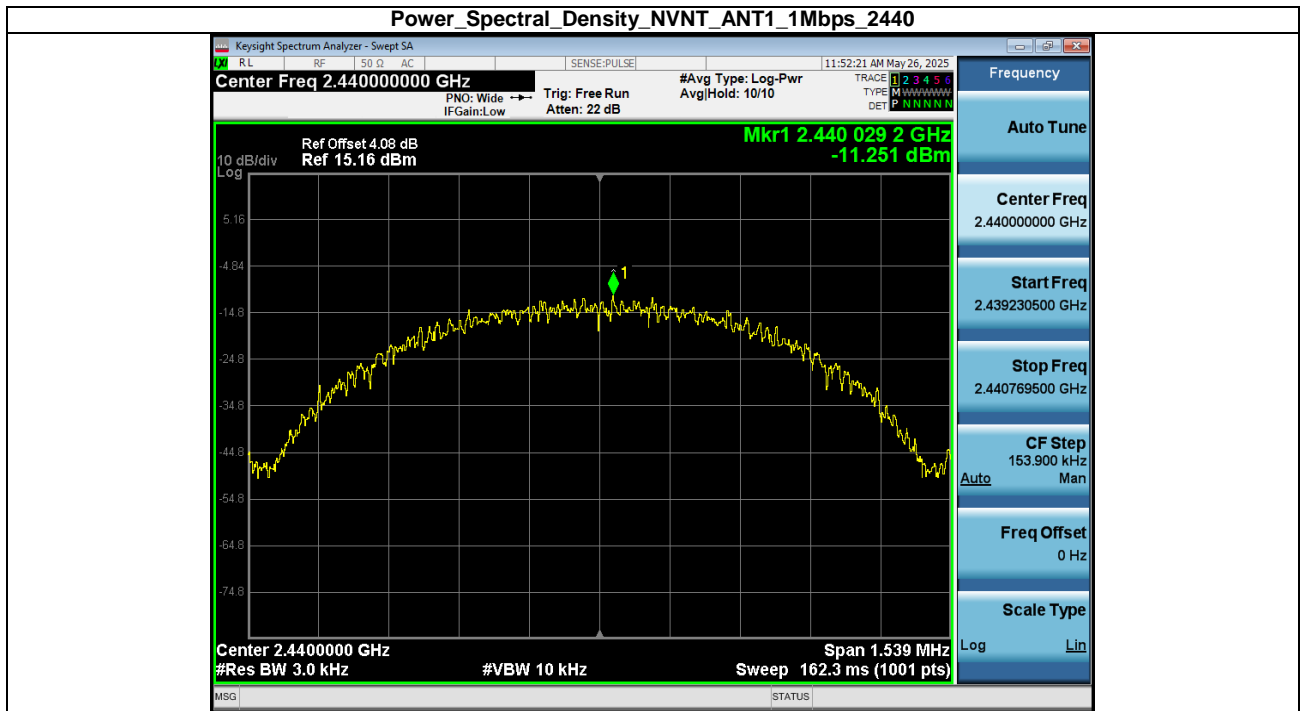
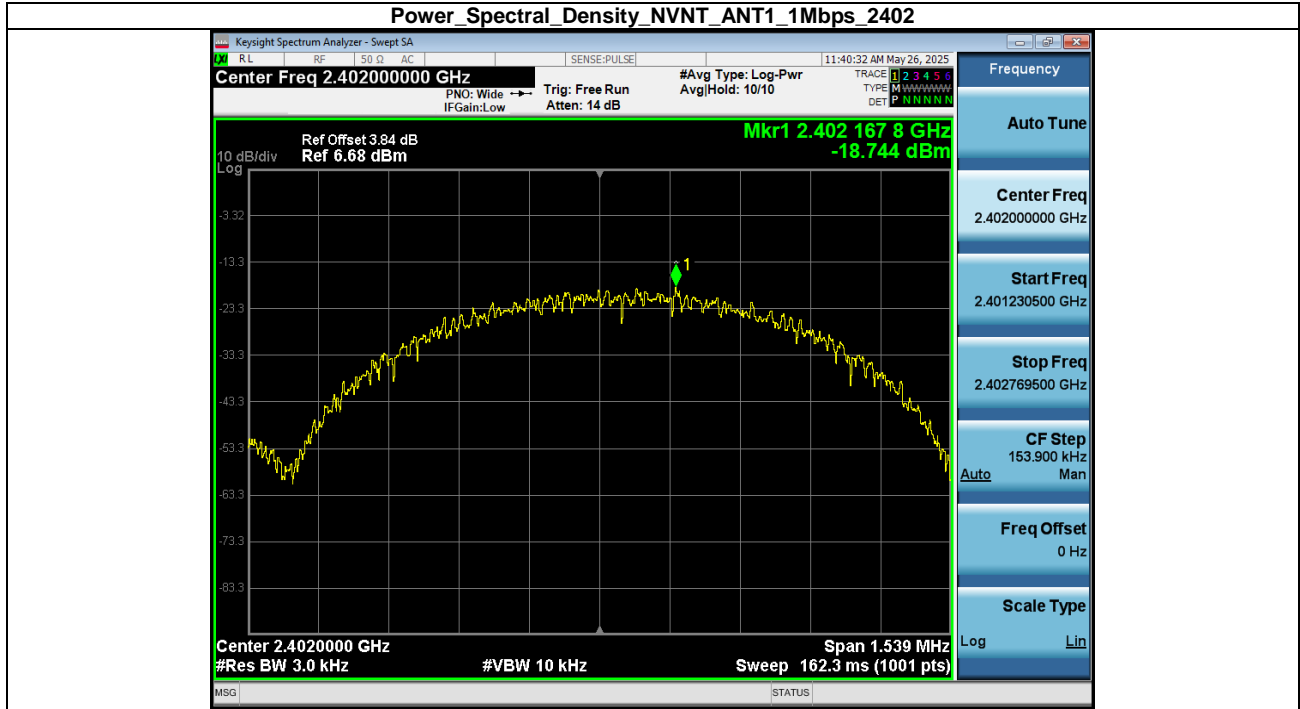

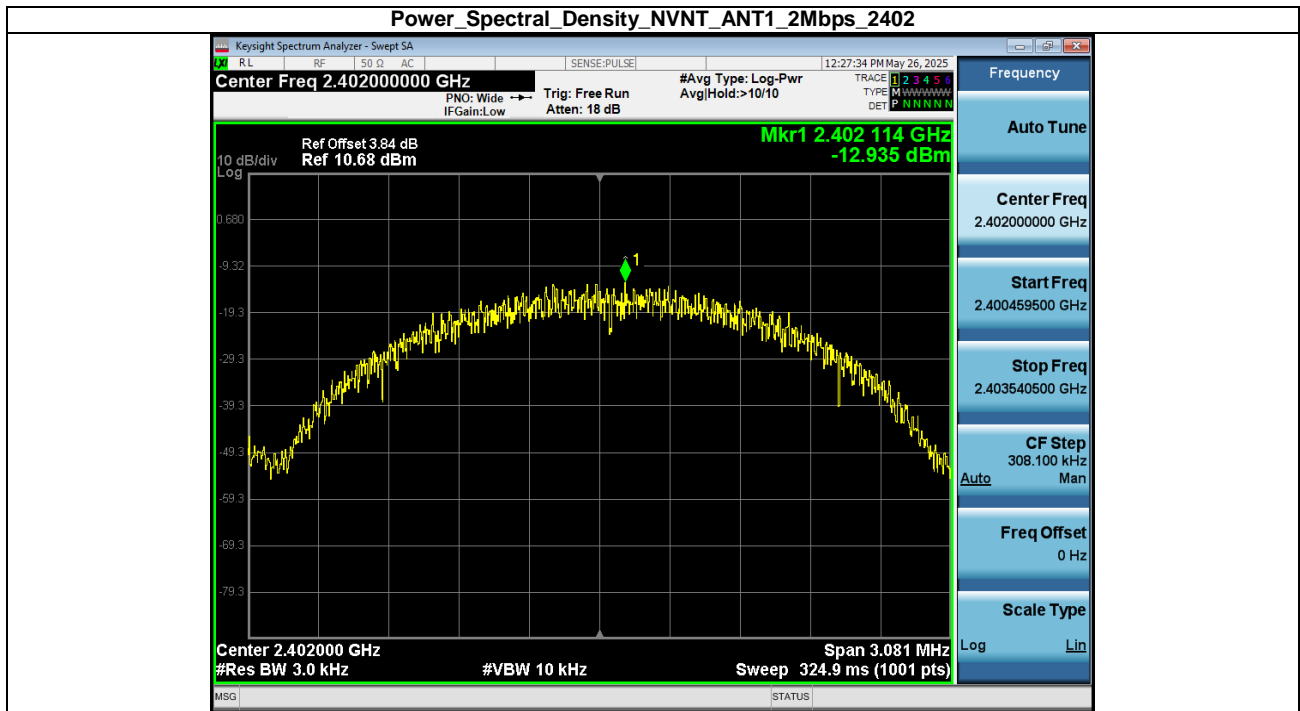
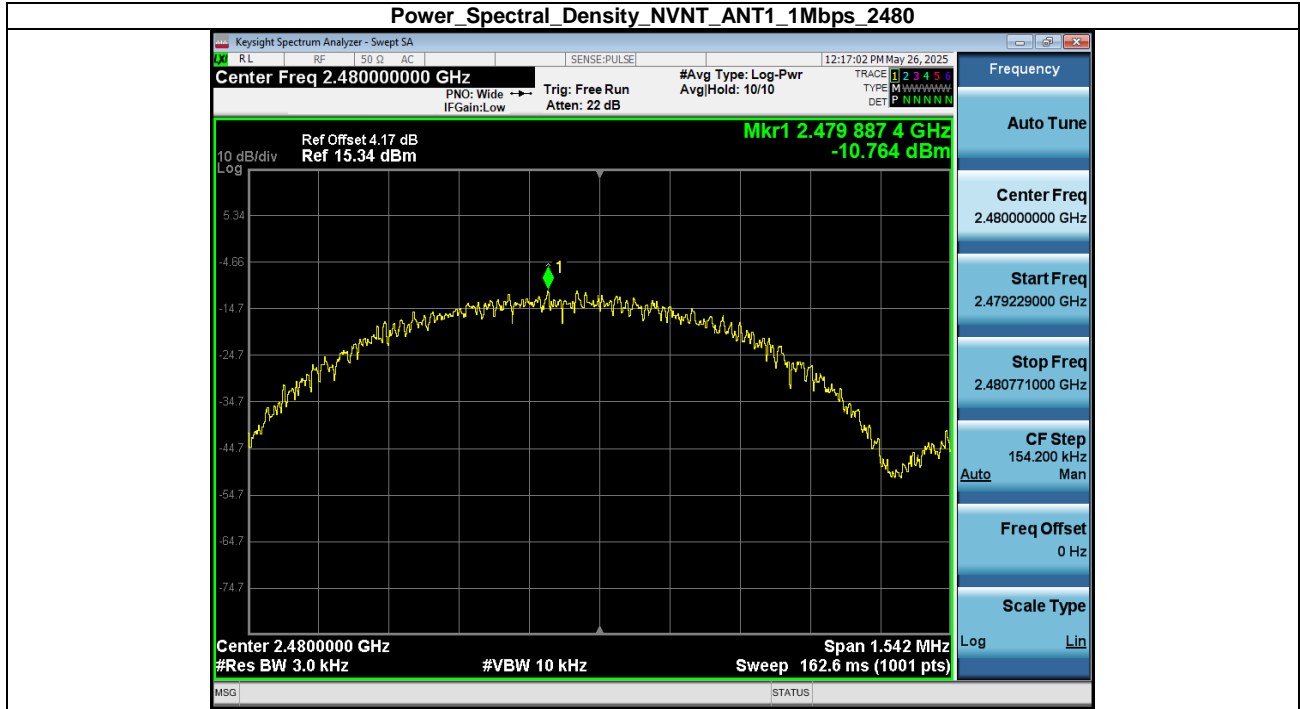

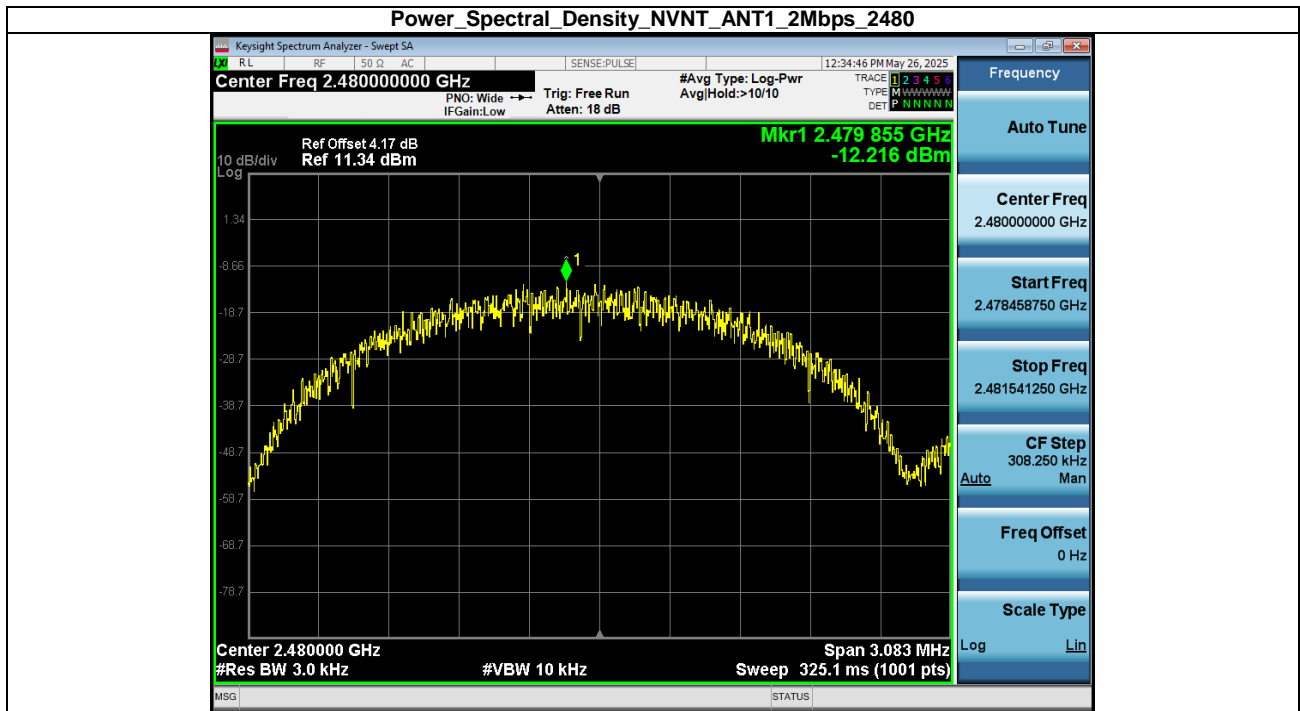
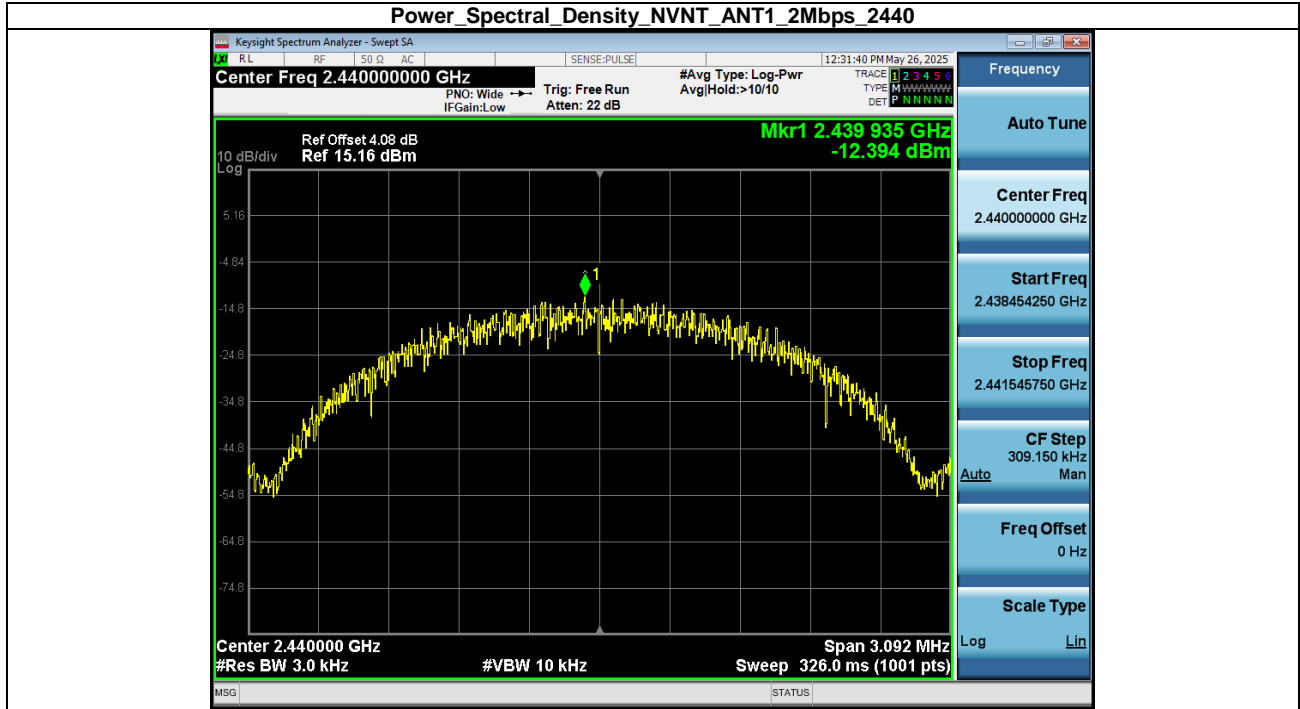

8. Bandwidth

8.1. Test limits

Please refer RSS-247 & FCC PART 15.247

For direct sequence systems, the minimum 6dB bandwidth shall be at least 500 kHz.

8.2. Test Procedure

Details see the KDB558074 D01 Meas Guidance v05r02

- a) The bandwidth is measured at an amplitude level reduced 6dB from the reference level. The reference level is the level of the highest amplitude signal observed from the transmitter at the fundamental frequency. Once the reference level is established, the equipment is conditioned with typical modulating signal to produce the worst-case (i.e. the widest) bandwidth.
- b) The test receiver set RBW = 100kHz, VBW \geq 3*RBW =300kHz,, Peak Detector, Sweep time set auto, detail see the test plot.

8.3. Test Setup

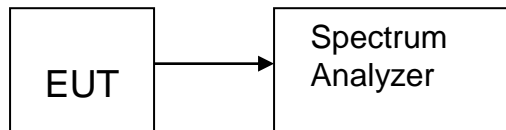

8.4. Test Results

| Condition | Antenna | Rate | Frequency (MHz) | -6dB BW(kHz) | limit(kHz) | Result |
|-----------|---------|-------|-----------------|--------------|------------|--------|
| NVNT | ANT1 | 1Mbps | 2402.00 | 764.11 | 500 | Pass |
| NVNT | ANT1 | 1Mbps | 2440.00 | 763.00 | 500 | Pass |
| NVNT | ANT1 | 1Mbps | 2480.00 | 758.17 | 500 | Pass |
| NVNT | ANT1 | 2Mbps | 2402.00 | 1406.43 | 500 | Pass |
| NVNT | ANT1 | 2Mbps | 2440.00 | 1513.78 | 500 | Pass |
| NVNT | ANT1 | 2Mbps | 2480.00 | 1504.46 | 500 | Pass |

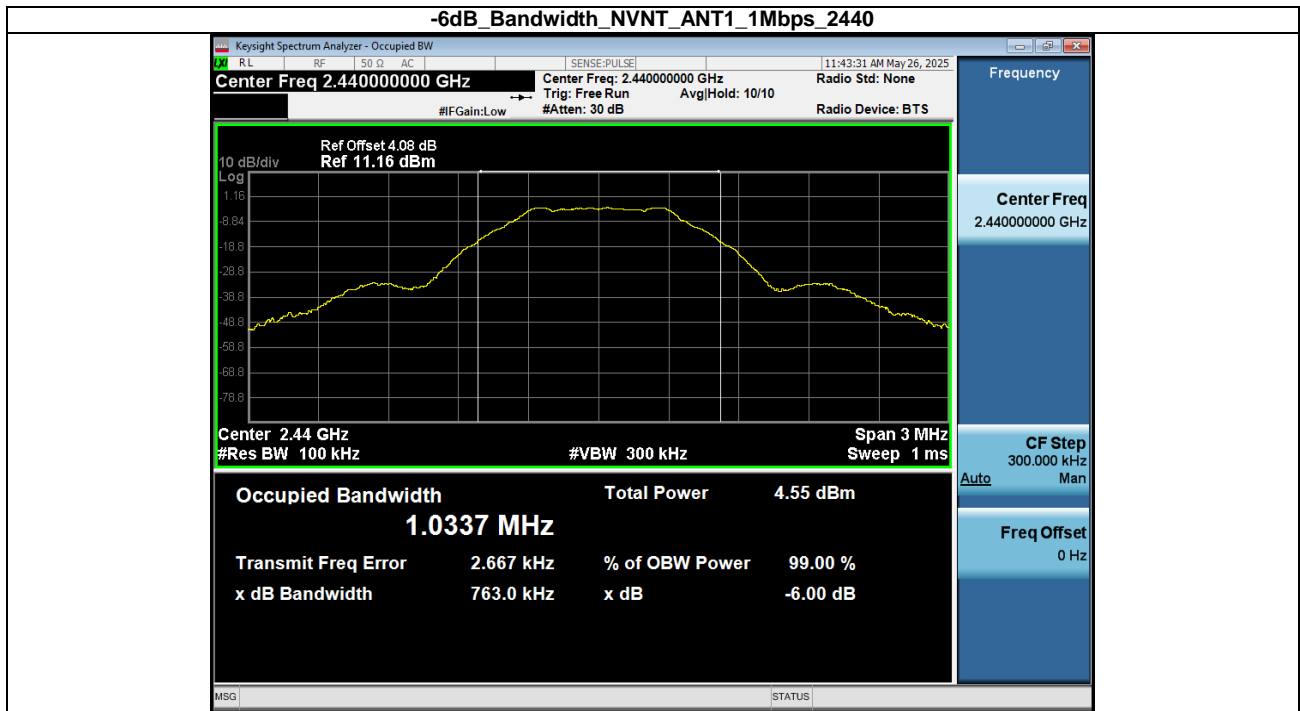
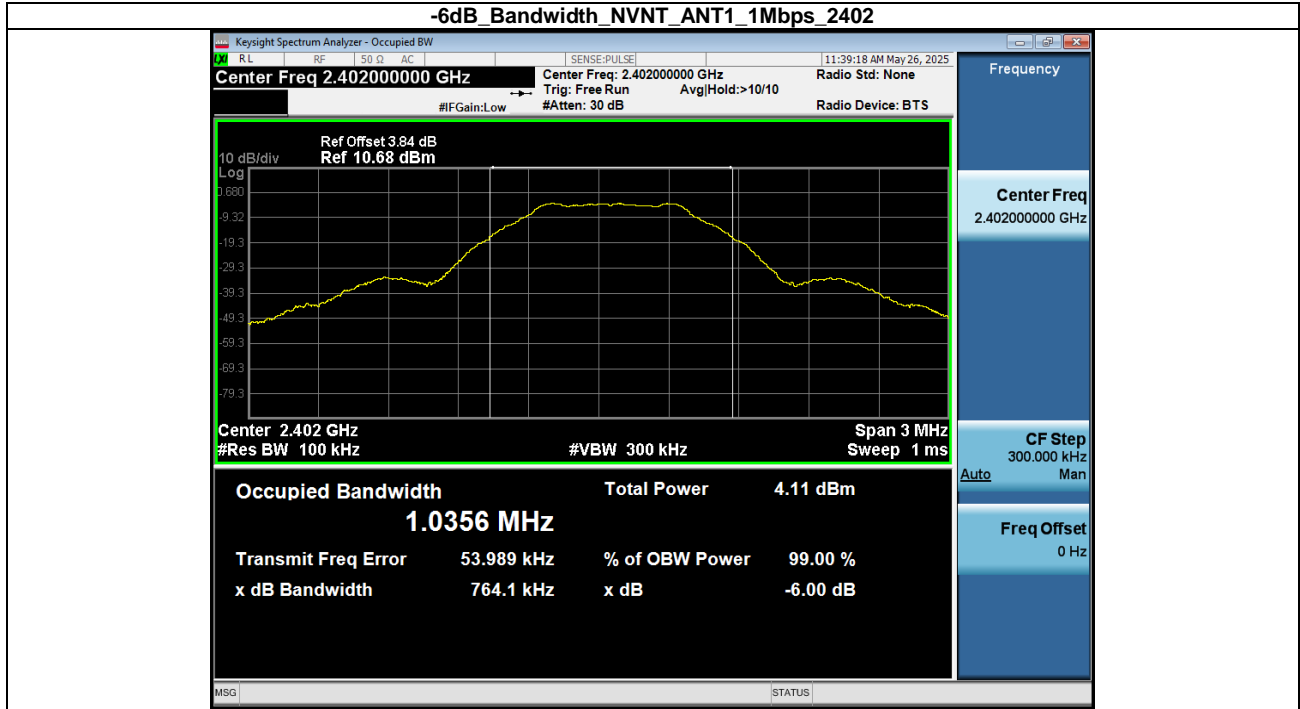

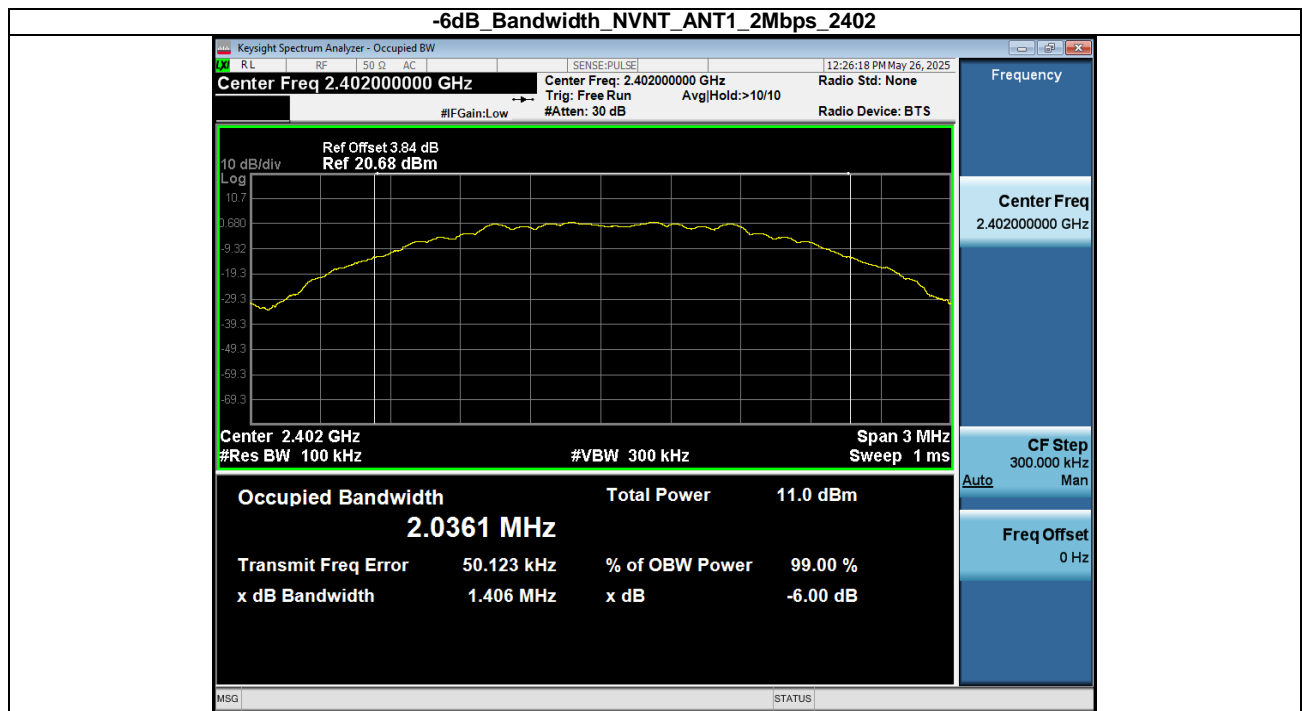
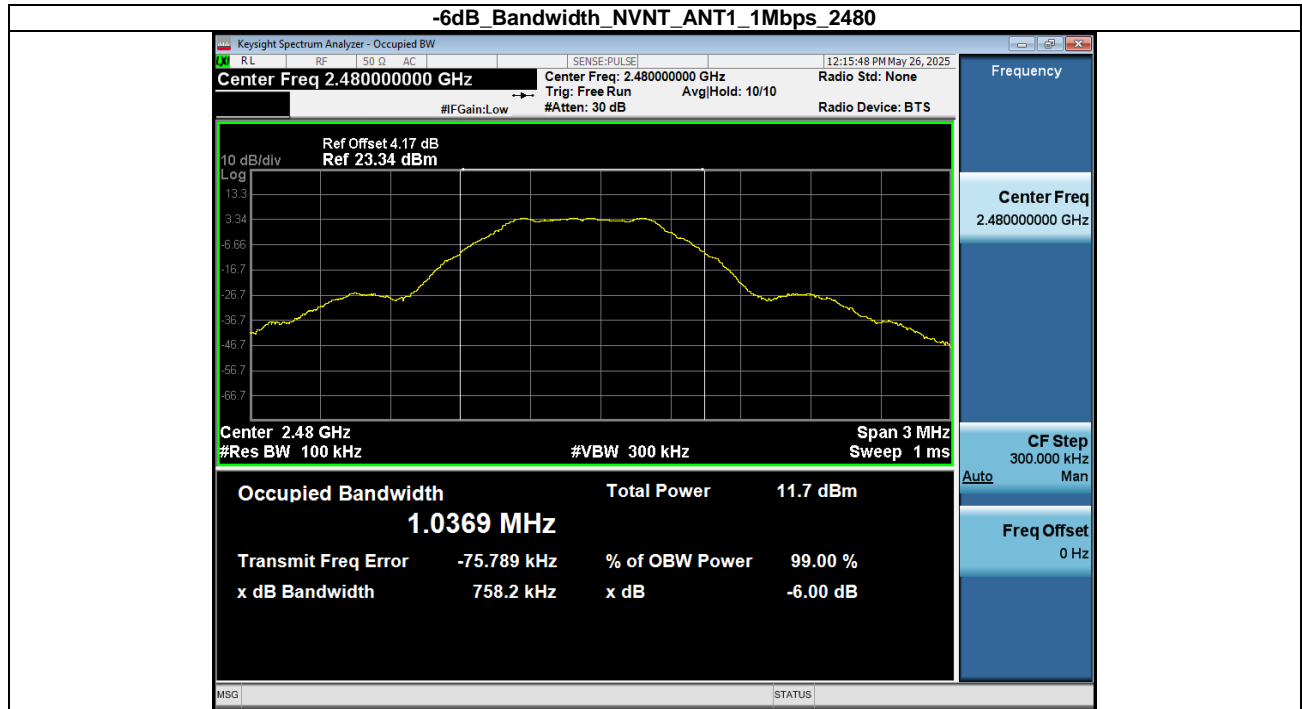

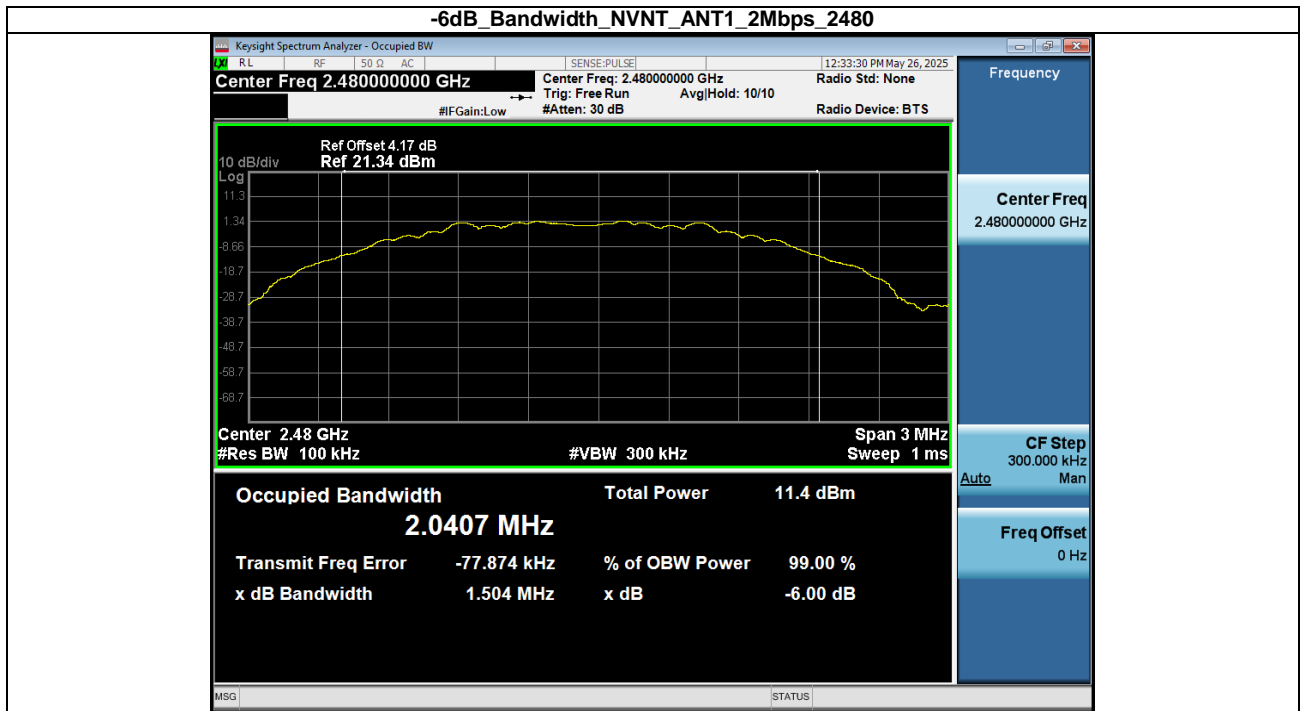
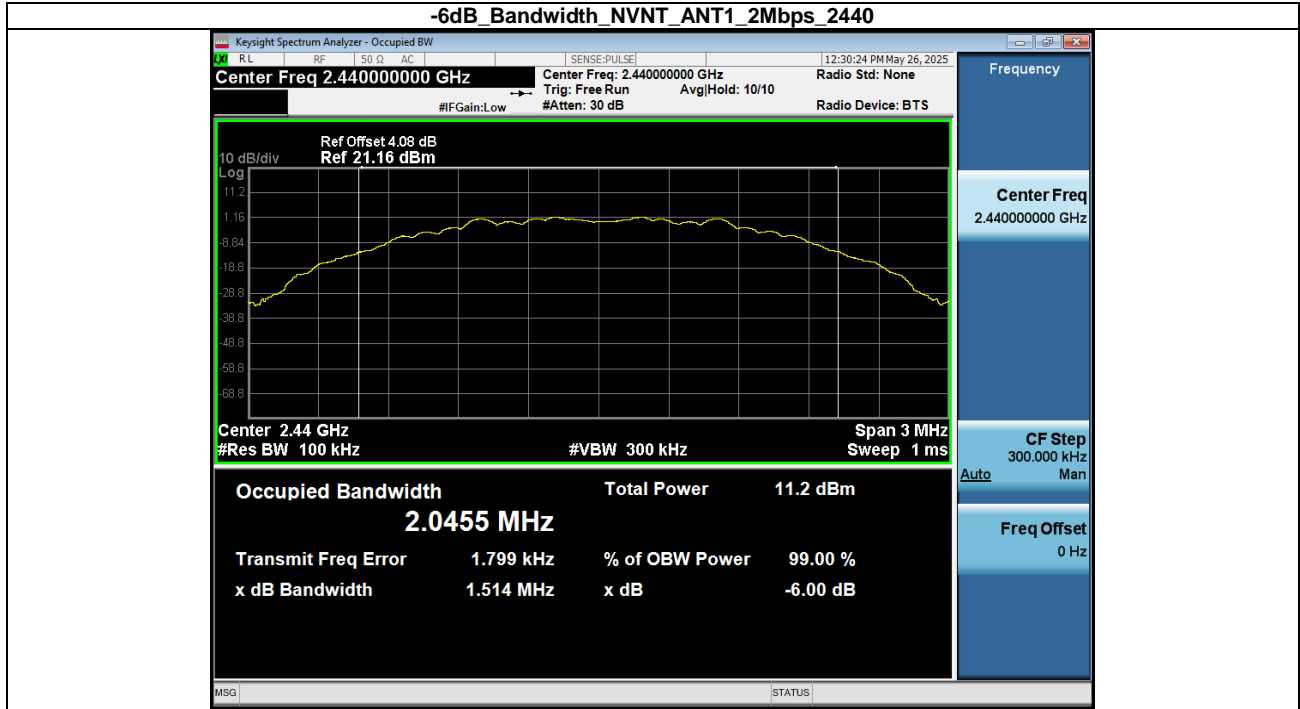

| Condition | Antenna | Rate | Frequency (MHz) | 99%OBW(MHz) |
|-----------|---------|-------|-----------------|-------------|
| NVNT | ANT1 | 1Mbps | 2402.00 | 1.026 |
| NVNT | ANT1 | 1Mbps | 2440.00 | 1.026 |
| NVNT | ANT1 | 1Mbps | 2480.00 | 1.028 |
| NVNT | ANT1 | 2Mbps | 2402.00 | 2.054 |
| NVNT | ANT1 | 2Mbps | 2440.00 | 2.061 |
| NVNT | ANT1 | 2Mbps | 2480.00 | 2.055 |

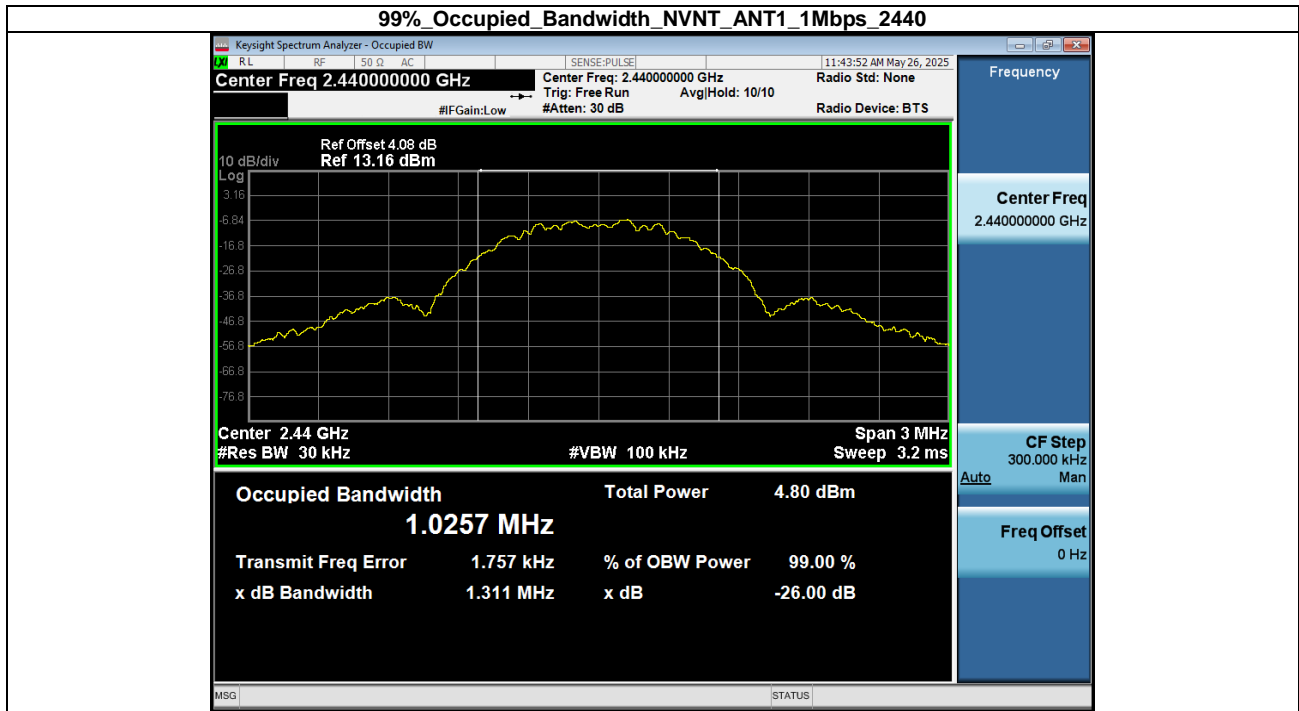
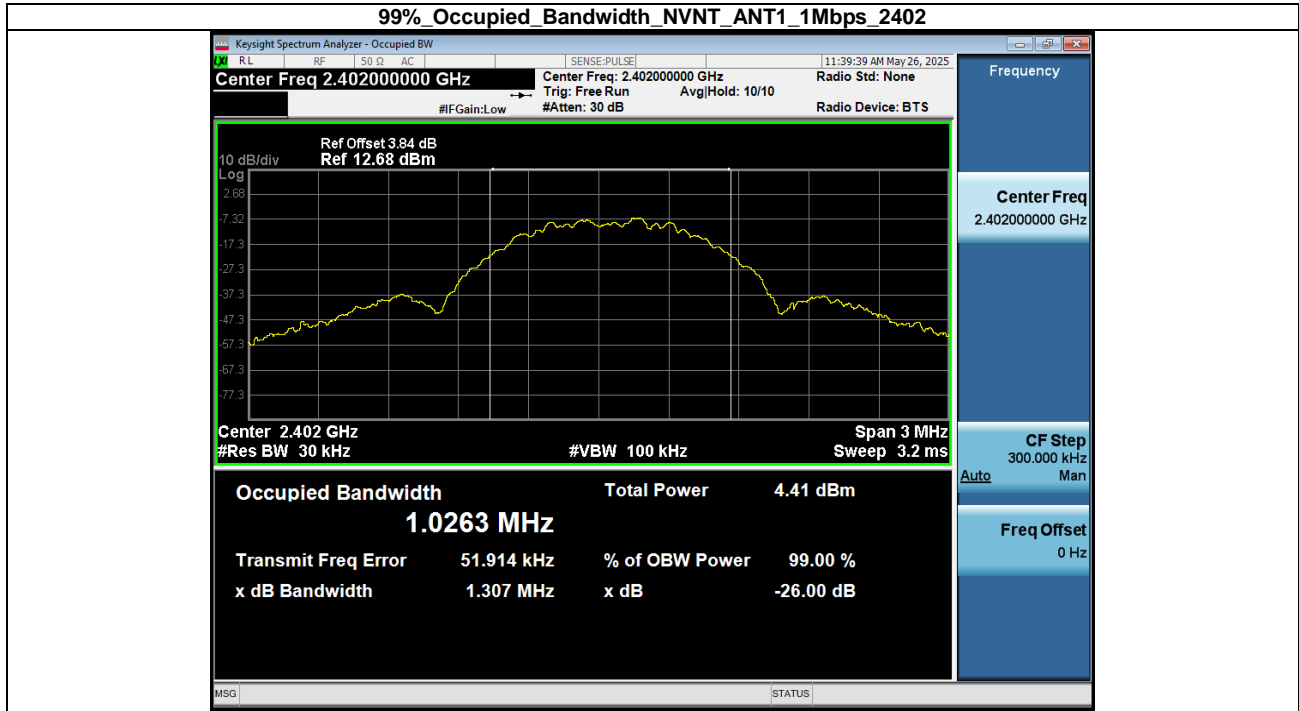

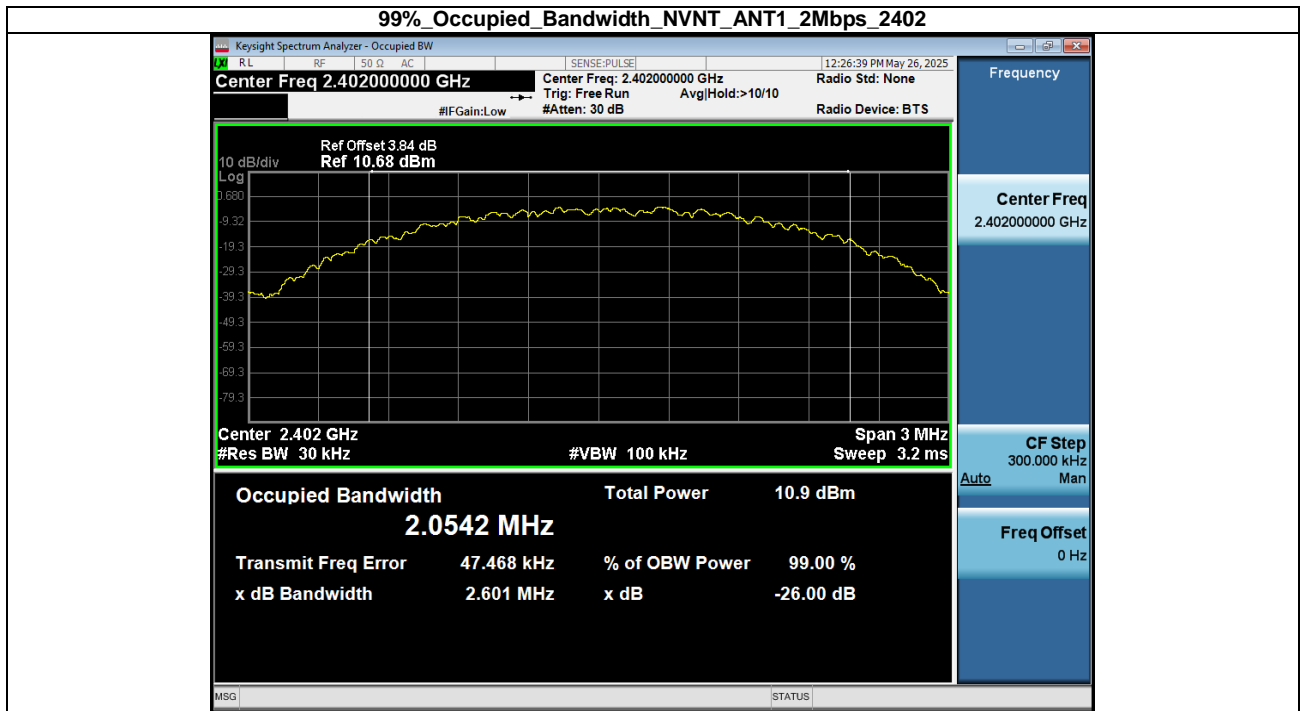
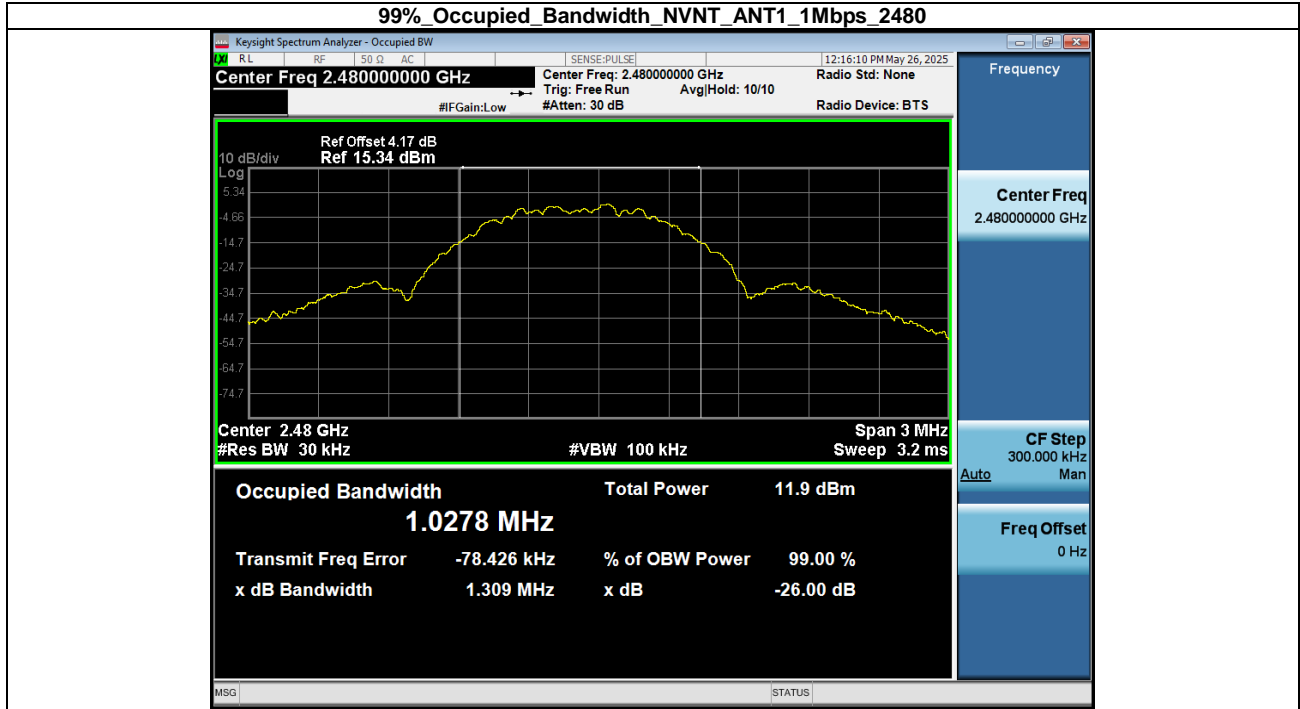

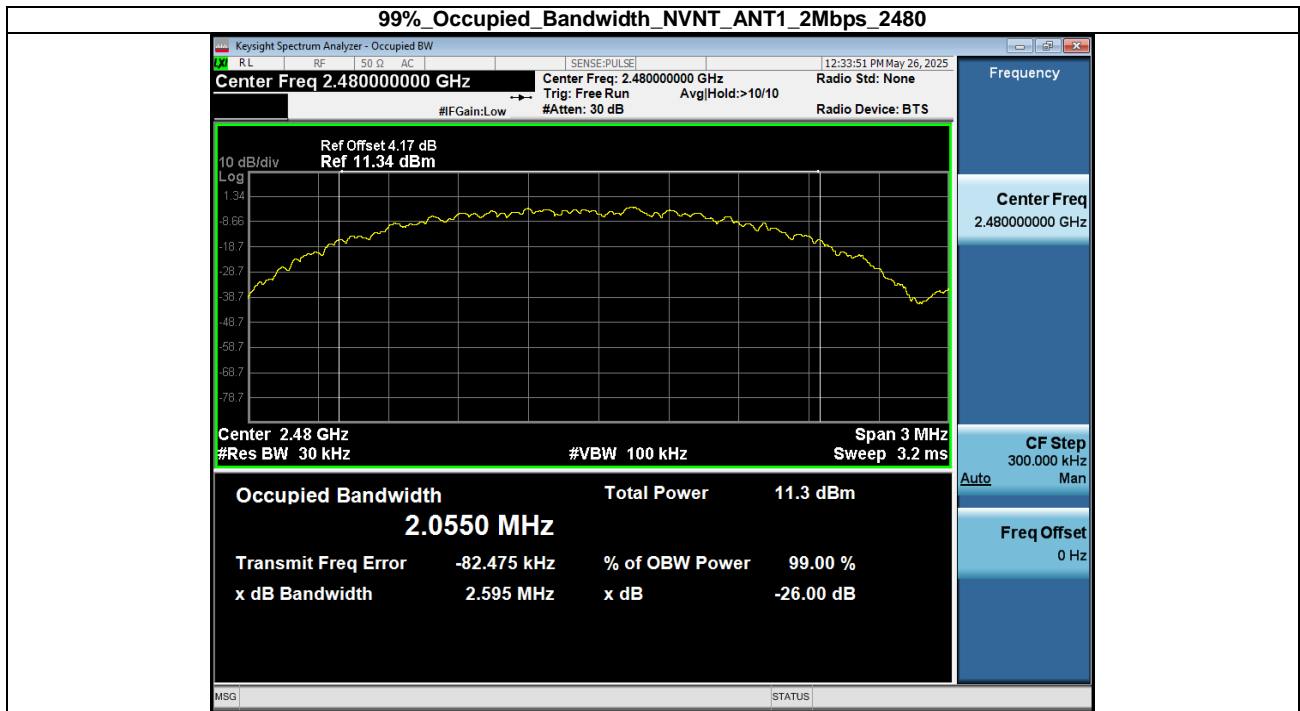
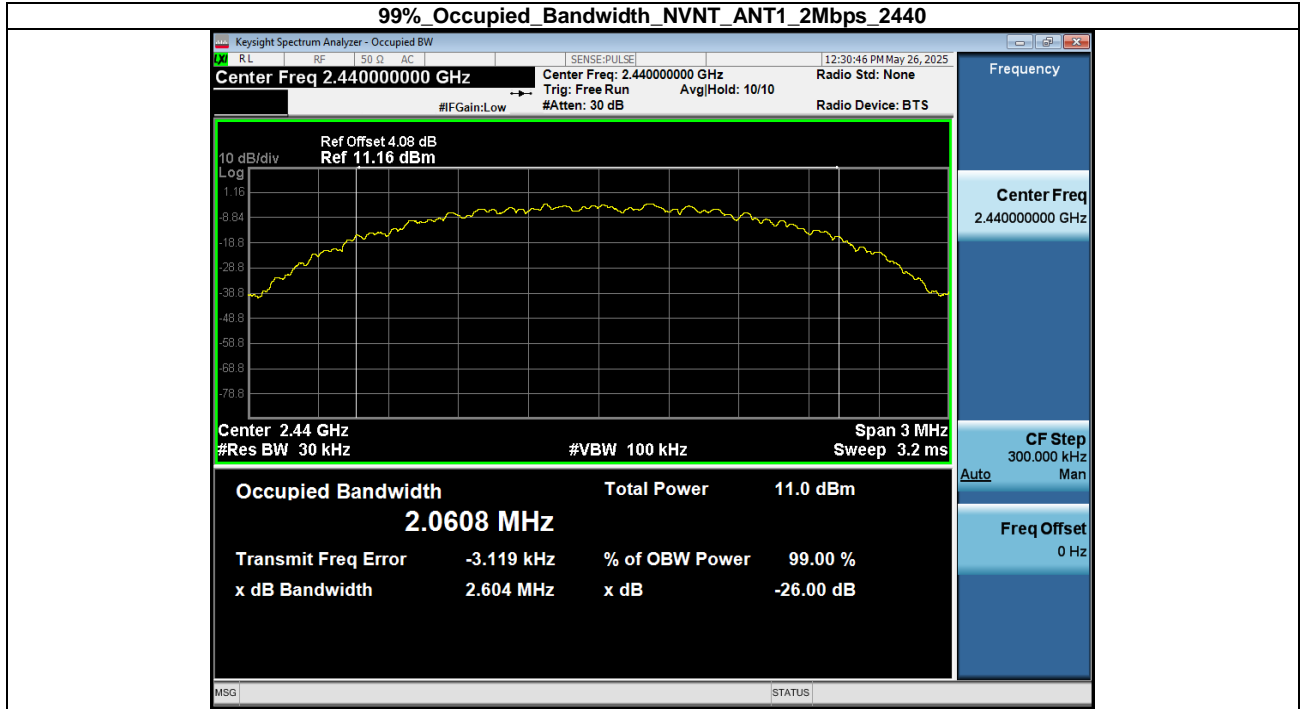

9. Band Edge Test

9.1. Block Diagram of Test Setup

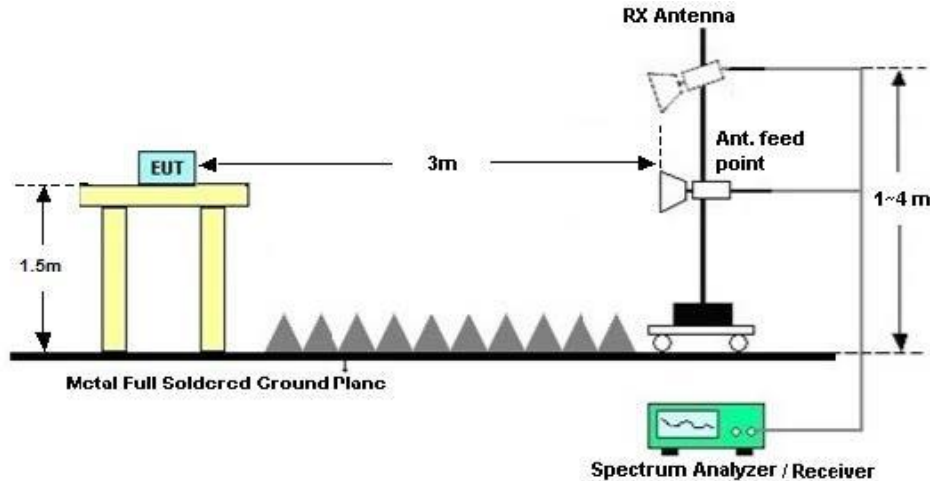

9.2. Test Limit

radiated emissions which fall in the restricted bands, as defined in § 15.205(a), must also comply with the radiated emission limits specified in § 15.209(a) (see § 15.205(c))

Please refer section RSS-GEN&15.247.

9.3. Test Procedure

Refer to ANSI C 63.10, Clause 6.10.

All restriction band and non- restriction band have been tested, only worse case is reported.

Details see the KDB558074 D01 Meas Guidance v05r02

1. Put the EUT on a 0.1m high table, power on the EUT. Emissions were scanned and measured rotating the EUT to 360 degrees, Find the maximum Emission
2. Check the spurious emissions out of band.
3. RBW 1MHz, VBW 3MHz, peak detector for peak value, RBW 1MHz, VBW 10Hz, RMS detector for AV value.

9.4. Test Results

| Test Date : 2025.05.26 | | | | | Temperature : 26°C | | | |
|--|---|----------|------------------|----------------|--------------------|----------------|--------|--------|
| Test Engineer : Felix Pang | | | | | Humidity : 54% | | | |
| Test Results : PASS | | | | | | | | |
| Frequency Range : 2310MHz~2410MHz | | | | | | | | |
| Test Mode : 1Mbps: GFSK TX 2402MHz | | | | | | | | |
| No. | Freq MHz | Polarity | Reading (dBuV/m) | Correct Factor | Result (dBuV/m) | Limit (dBuV/m) | Margin | Remark |
| 1 | 2390 | H | 78.22 | -20.45 | 57.77 | 74.00 | -16.23 | Peak |
| 2 | 2390 | H | -- | -20.45 | -- | 54.00 | -- | Avg |
| 3 | 2400 | H | 81.45 | -20.41 | 61.04 | 74.00 | -12.96 | Peak |
| 4 | 2400 | H | -- | -20.41 | -- | 54.00 | -- | Avg |
| | | | | | | | | |
| 1 | 2390 | V | 75.72 | -20.45 | 55.27 | 74.00 | -18.73 | Peak |
| 2 | 2390 | V | -- | -20.45 | -- | 54.00 | -- | Avg |
| 3 | 2400 | V | 83.76 | -20.41 | 63.35 | 74.00 | -10.65 | Peak |
| 4 | 2400 | V | -- | -20.41 | -- | 54.00 | -- | Avg |
| | | | | | | | | |
| Frequency Range : 2450MHz~2550MHz | | | | | | | | |
| Test Mode : 1Mbps: GFSK TX 2480MHz | | | | | | | | |
| 1 | 2483.5 | H | 81.09 | -20.15 | 60.94 | 74.00 | -13.06 | Peak |
| 2 | 2483.5 | H | -- | -20.15 | -- | 54.00 | -- | Avg |
| | | | | | | | | |
| 1 | 2483.5 | V | 78.41 | -20.15 | 58.26 | 74.00 | -15.74 | Peak |
| 2 | 2483.5 | V | -- | -20.15 | -- | 54.00 | -- | Avg |
| | | | | | | | | |
| Note: | <p>1. Means other frequency and mode comply with standard requirements and at least have 20dB margin.</p> <p>2. Correct Factor=Cable Loss+ Antenna Factor-Amplifier Gain. Result=Reading + Correct Factor. Margin= Result-Limit.</p> <p>3. If the limits for the measurement with the average detector are met when using a receiver with a peak detector, the test unit shall be deemed to meet both limits and the measurement with the average detector need not be carried out.</p> | | | | | | | |

| Frequency Range : 2310MHz~2410MHz | | | | | | | | |
|--|---|----------|------------------|----------------|-----------------|----------------|--------|--------|
| Test Mode : 2Mbps: GFSK TX 2402MHz | | | | | | | | |
| No. | Freq MHz | Polarity | Reading (dBuV/m) | Correct Factor | Result (dBuV/m) | Limit (dBuV/m) | Margin | Remark |
| 1 | 2390 | H | 77.58 | -20.45 | 57.13 | 74.00 | -16.87 | Peak |
| 2 | 2390 | H | -- | -20.45 | -- | 54.00 | -- | Avg |
| 3 | 2400 | H | 82.66 | -20.41 | 62.25 | 74.00 | -11.75 | Peak |
| 4 | 2400 | H | -- | -20.41 | -- | 54.00 | -- | Avg |
| | | | | | | | | |
| 1 | 2390 | V | 74.75 | -20.45 | 54.30 | 74.00 | -19.70 | Peak |
| 2 | 2390 | V | -- | -20.45 | -- | 54.00 | -- | Avg |
| 3 | 2400 | V | 83.55 | -20.41 | 63.14 | 74.00 | -10.86 | Peak |
| 4 | 2400 | V | 77.58 | -20.45 | 57.13 | 74.00 | -16.87 | Avg |
| | | | | | | | | |
| Frequency Range : 2450MHz~2550MHz | | | | | | | | |
| Test Mode : 1Mbps: GFSK TX 2480MHz | | | | | | | | |
| 1 | 2483.5 | H | 80.90 | -20.15 | 60.75 | 74.00 | -13.25 | Peak |
| 2 | 2483.5 | H | -- | -20.15 | -- | 54.00 | -- | Avg |
| | | | | | | | | |
| 1 | 2483.5 | V | 78.73 | -20.15 | 58.58 | 74.00 | -15.42 | Peak |
| 2 | 2483.5 | V | -- | -20.15 | -- | 54.00 | -- | Avg |
| | | | | | | | | |
| Note: | 1. Means other frequency and mode comply with standard requirements and at least have 20dB margin. 2. Correct Factor=Cable Loss+ Antenna Factor-Amplifier Gain. Result=Reading + Correct Factor. Margin= Result-Limit. 3. If the limits for the measurement with the average detector are met when using a receiver with a peak detector, the test unit shall be deemed to meet both limits and the measurement with the average detector need not be carried out. | | | | | | | |

10. Frequency stability

10.1. Test limit

Please refer section RSS-Gen.

Regulation RSS-Gen If the frequency stability of the licence-exempt radio apparatus is not specified in the applicable RSS, the fundamental emissions of the radio apparatus should be kept within at least the central 80% of its permitted operating frequency band in order to minimize the possibility of out-of-band operation. In addition, its occupied bandwidth shall be entirely outside the restricted bands and the prohibited TV bands of 54-72 MHz, 76-88 MHz, 174-216 MHz, and 470-602 MHz, unless otherwise indicated.

10.2. Test Procedure

The following equipment are installed on the emission measurement to meet the commission requirements and operating regulations in a manner which tends to maximize its emission characteristics in normal application.

10.3. Test Setup

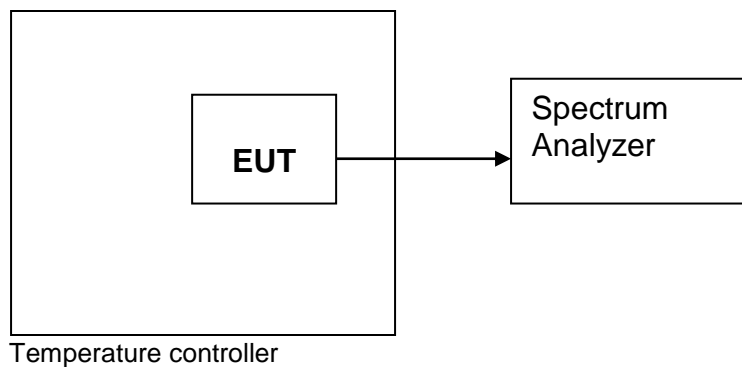

10.4. Test Results

Not Applicable.

11. Antenna Requirement

11.1. Standard Requirement

An intentional radiator shall be designed to ensure that no antenna other than that furnished by the responsible party shall be used with the device. The use of a permanently attached antenna or of an antenna that uses a unique coupling to the intentional radiator shall be considered sufficient to comply with the provisions of this Section. The manufacturer may design the unit so that a broken antenna can be replaced by the user, but the use of a standard antenna jack or electrical connector is prohibited.

11.2. Antenna Connected Construction

The antenna connector is unique antenna and no consideration of replacement. Please see EUT photo for details.

11.3. Results

The EUT antenna is PCB antenna. It complies with the standard requirement.

12. Photos of test setup

Reference to the **appendix I Test Setup Photo** for details.

13. Photos of EUT

Reference to the **appendix II external photos** and **appendix III internal photos** for details.

----- END OF REPORT-----

Appendix I Test Setup Photo

FCC ID: 2A8QD-XY-MB06BA

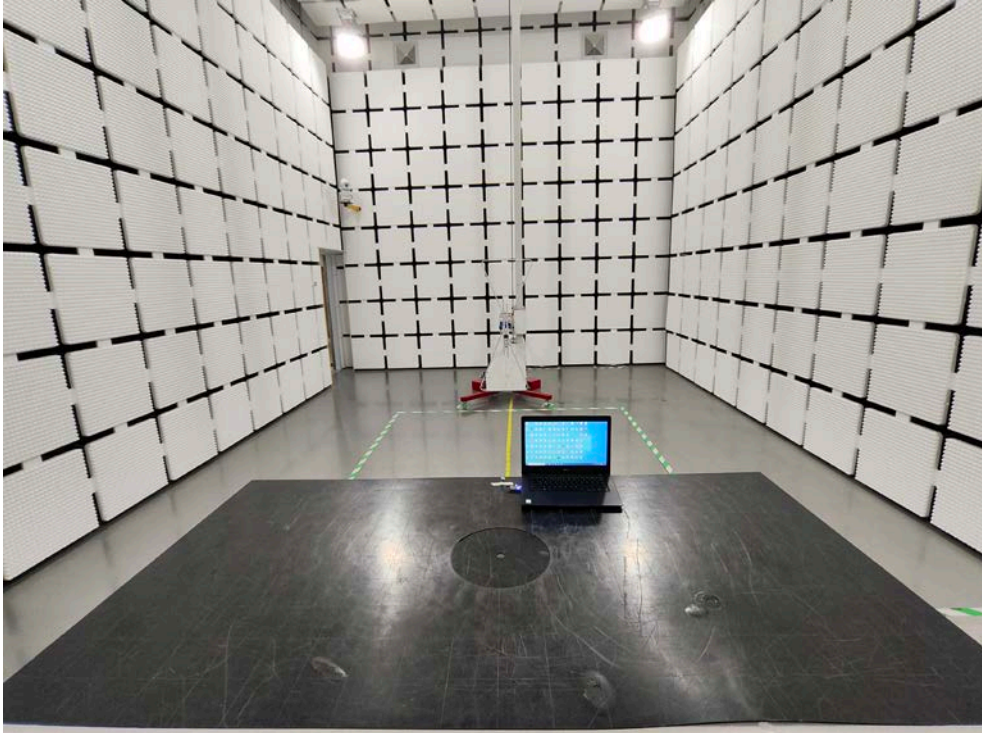

Spurious Radiation Emissions Test (<1G)



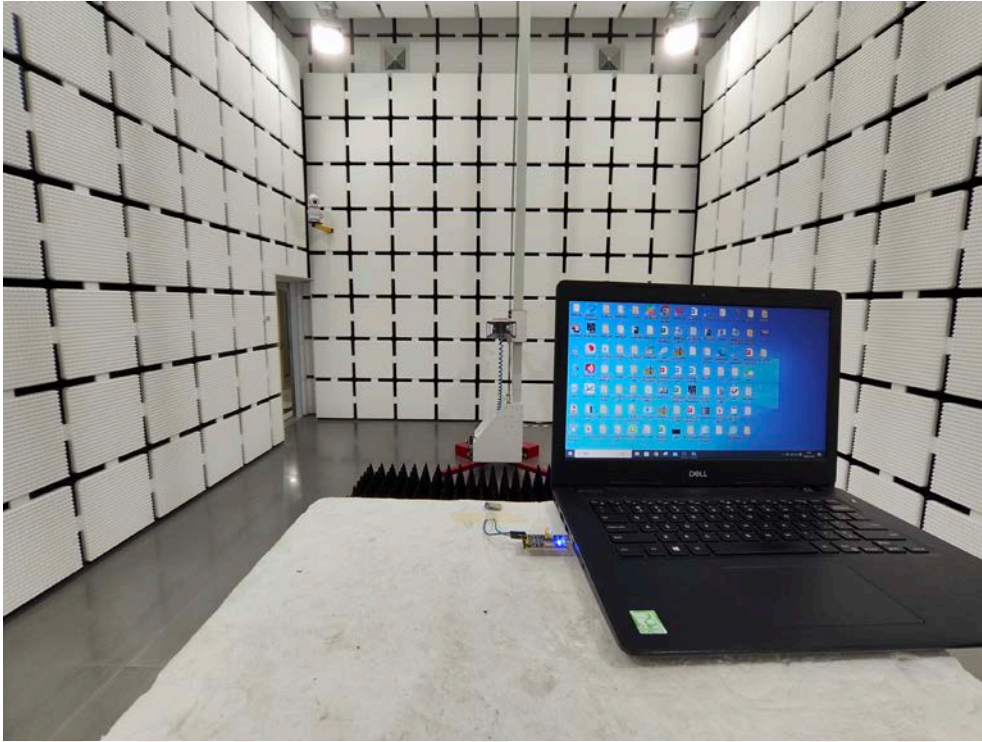

Spurious Radiation Emissions Test (> 1G)



Conducted emission Test

-----End-----

Appendix II external photos

FCC ID: 2A8QD-XY-MB06BA

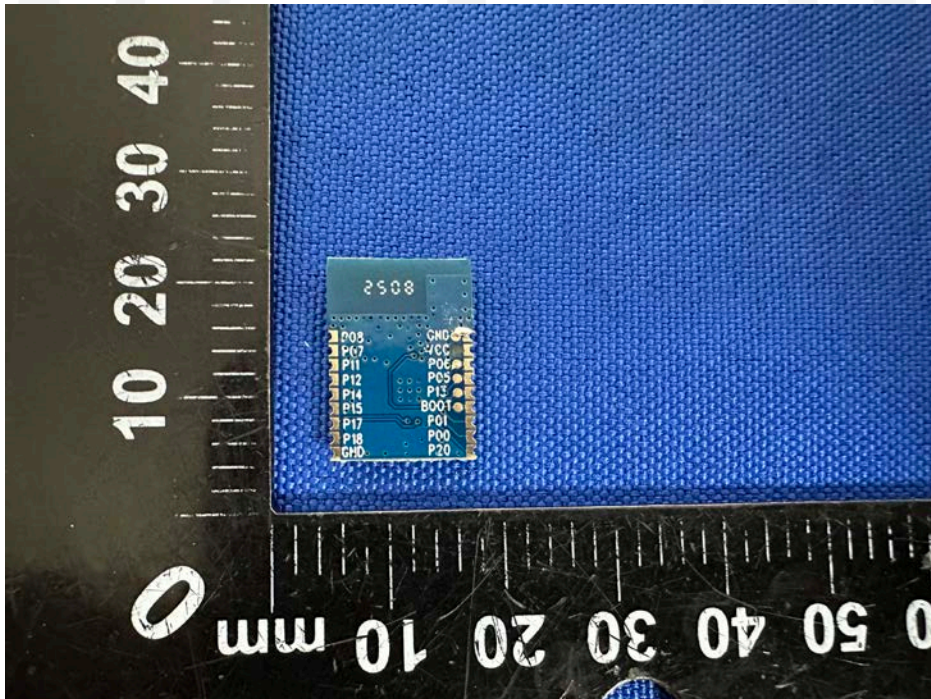
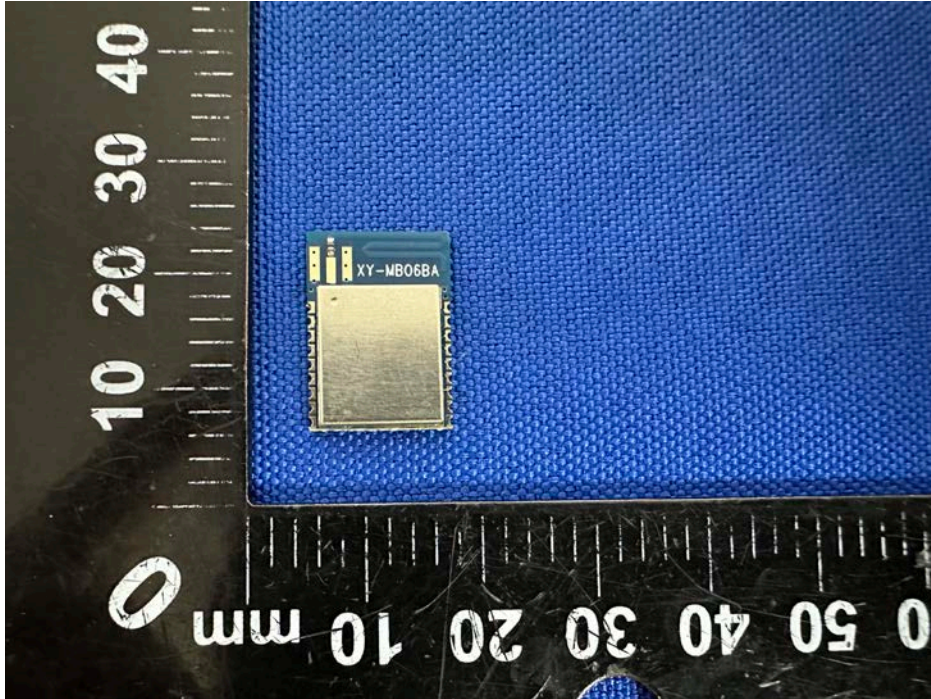

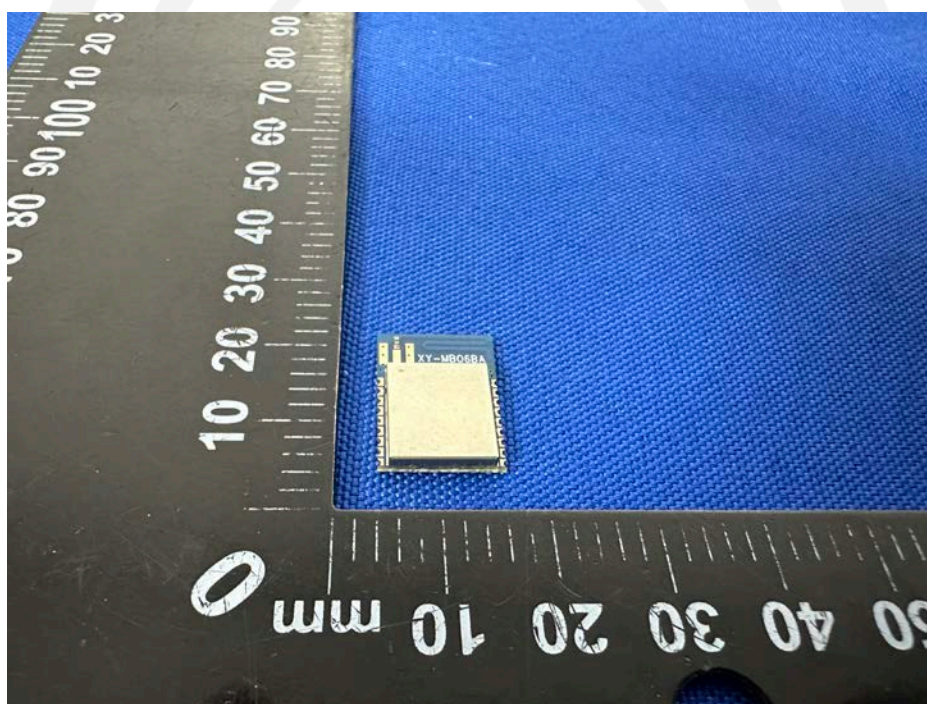
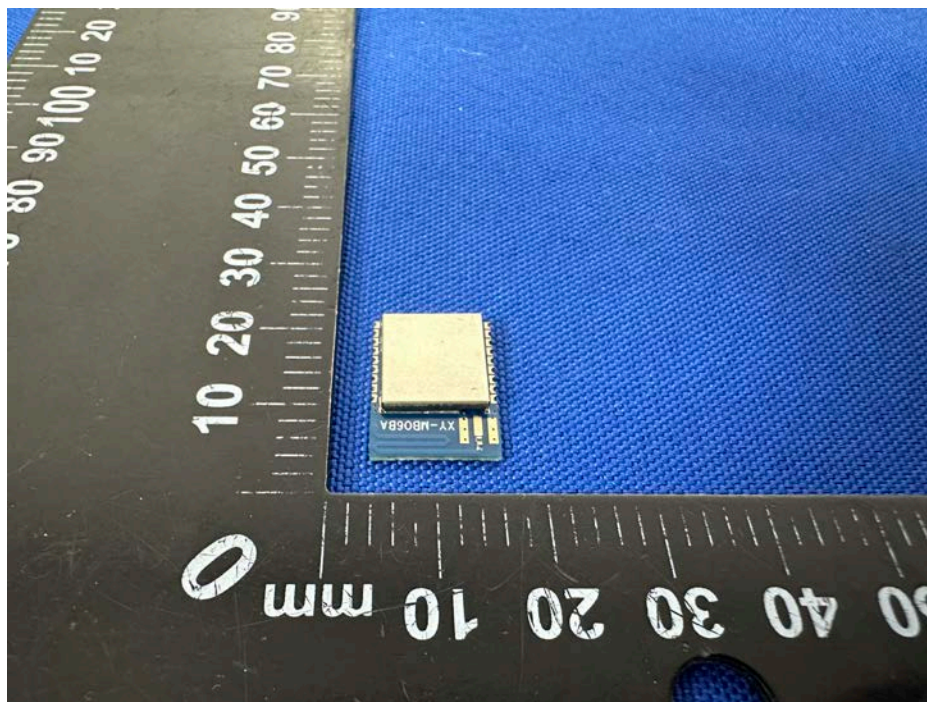

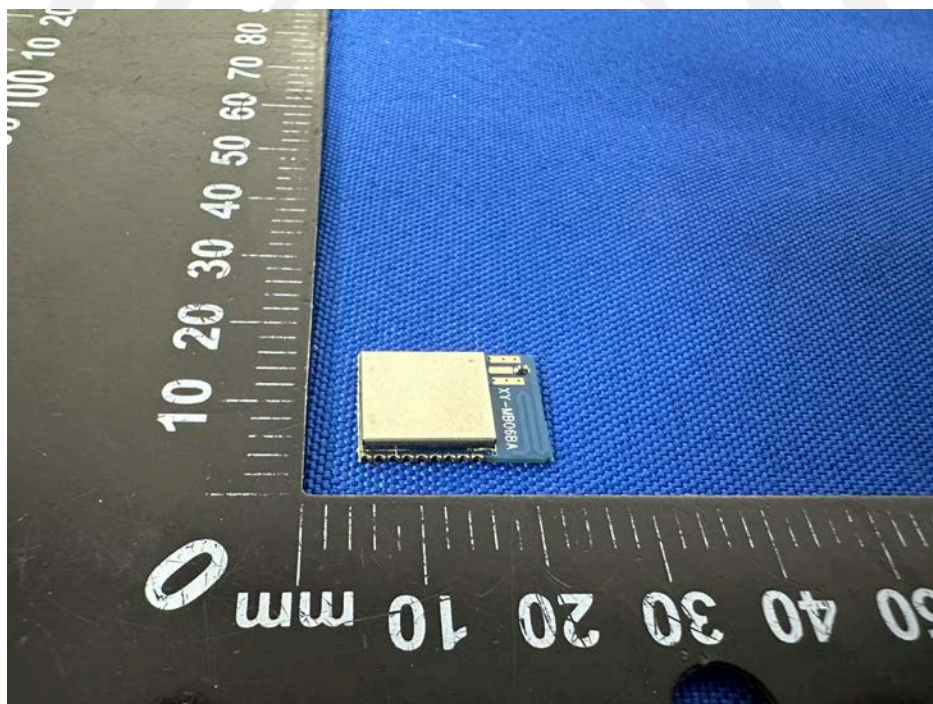
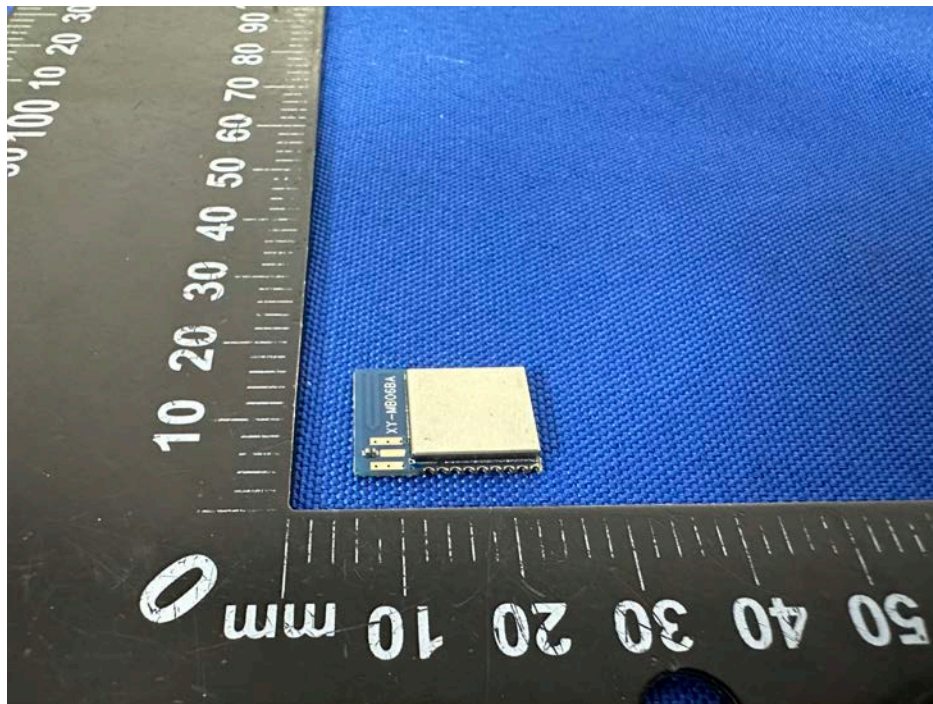

-----End-----

Appendix III internal photos

FCC ID: 2A8QD-XY-MB06BA

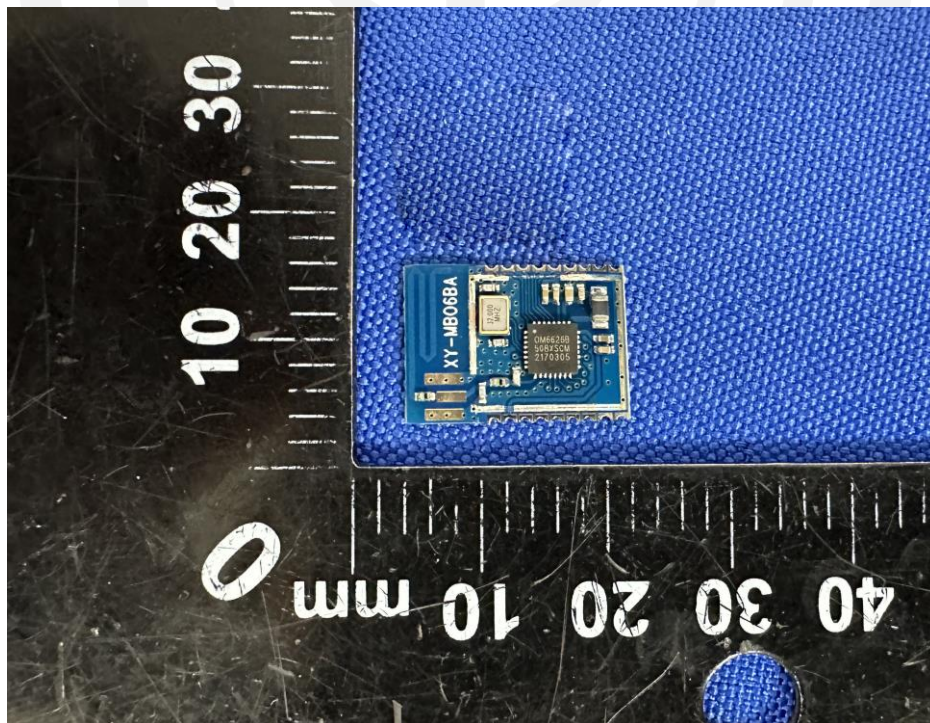
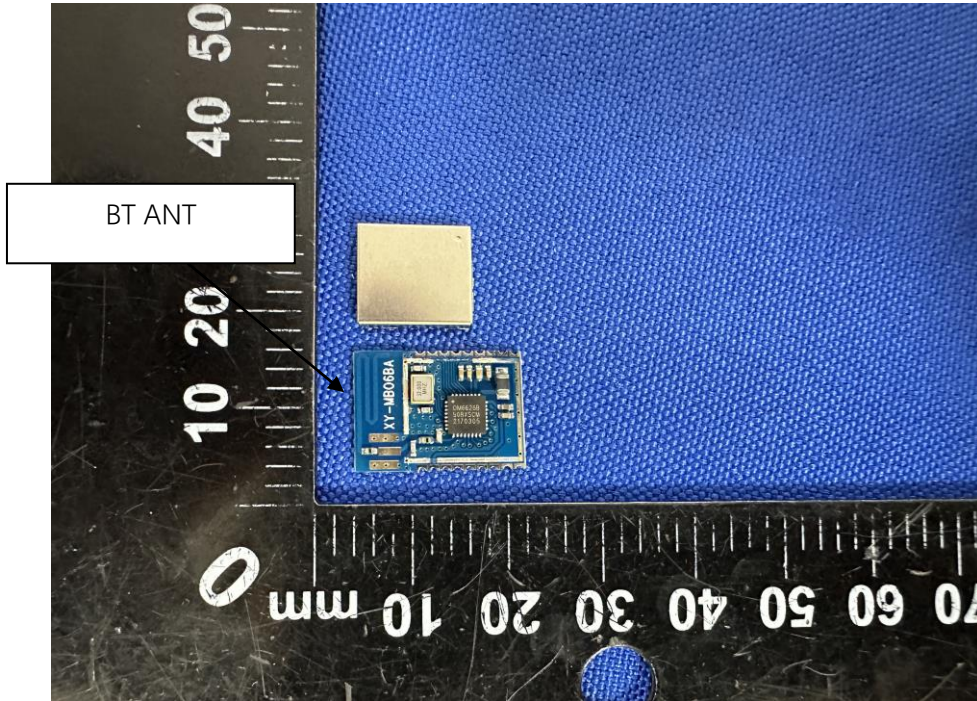

-----End-----